

# ANNUAL REPORT

## 2014-2015



प्लाज़्मा अनुसंधान संस्थान

Institute for **Plasma Research**

Bhat, Gandhinagar 382428

## GOVERNING COUNCIL

- |                          |                      |
|--------------------------|----------------------|
| 1) Dr. R.K. Sinha        | Chairman             |
| 2) Dr. D. Bora           | Member               |
| 3) Dr. Amit Roy          | Member               |
| 4) Shri Sekar Basu       | Member               |
| 5) Dr. J. N. Goswami     | Member               |
| 6) Dr. Siraj Hasan       | Member               |
| 7) Shri P.R. Bhaviskar   | Member               |
| 8) Shri R. A. Rajeev     | Member               |
| 9) Shri Mukesh Puri      | Member               |
| 10) Shri Sanjay Lal Bhai | Member               |
| 11) Shri P. K. Atrey     | Non-Member Secretary |

## EXECUTIVE SUMMARY

This has been a year of 'up-gradation'. After giving consistent operating performance, in its silver jubilee year, it was decided that Aditya will be up graded to have a shaped plasma cross section. An additional set of coils and the vacuum vessel are being changed to achieve this. Before dis-assembly, Aditya operations were done at higher parameters of toroidal magnetic field at 1.26 Tesla. Plasma current of as high as 160 kAmp and temperature well above 5 million degrees were obtained for almost quarter of a second. The new vacuum vessel is already accepted at site. We will soon have Aditya back in action.

In the Steady-state Superconducting Tokamak-1 (SST-1) maximum plasma current of 75000 A at a Toroidal magnetic field of 1.5 T at the plasma centre assisted with Electron Cyclotron (EC) pre-ionization at the fundamental mode was achieved. These Mega Joule class toroidal magnetic fields were also operated upto 2.0T. Such magnets were cooled by two phase helium flow at cryogenic temperature for the first time in the world. Since then, the first stage of up-gradation with graphite plasma facing components in the machine has been completed along with all the cooling and baking facilities. All the diagnostics have also been upgraded with some new diagnostics in place. First successful launching of Lower Hybrid Current Drive waves has been conducted.

Under the ambit of the 12th Five Year Plan various technologies required to realize the fusion power are being developed to indigenize the whole spectrum of relevant technologies. For the development of the superconducting magnet technology, a facility for vacuum pressure impregnation has been developed to manufacture strands along with material characterization facility at ultra-low temperatures. In the already installed High Heat Flux Testing Facility, thermal fatigue testing of tungsten materials and other relevant materials are being done. Other facilities for the fabrication of plasma facing components with special materials are also being established. With the development of Single Panel Cryo-pumping Facility, pumping speed of ~10000 l/s was successfully demonstrated and were presented and accepted by the national experts.

To fulfil the commitment of delivering the Test Blanket Module (TBM) to ITER project, various small experimental set ups like liquid metal heat transfer loop, experimental Helium Cooling Loop etc are being done to understand and develop the required technologies. For the remote handling and robotics technology, various prototypes are being made and tested. A laboratory scale hydrogen isotope removal system (HIRS) for Helium purge gas to validate design concepts for tritium extraction is being developed.

The doctoral programme of the institute is mostly supported by small basic experiments, which also caters to the manpower training and technology developments. Various new devices including the existing experimental systems are helping to perform different experimental ideas to explain and to exploit many plasma physics observations.

The results obtained from various experiments (both small and big) are being explained using plasma theory and simulations, attempts are also being made to explain observations from experiments, conducted elsewhere in the country through collaborations.

Exploration of societal benefits from plasma technologies is continued vigorously at Facilitation Centre for Industrial Plasma Technology (FCIPT). The projects cover various areas such as bio-medics, conventional and green power, textiles, waste management, nano-technology. FCIPT is working on developing Plasma Pyrolysis system (on proof of concept basis) for plastic and paper waste disposal at GIFT (Gujarat International Finance Tech) City - a smart city that is being developed near Gandhinagar, Gujarat.

For ITER-India, the procurement packages entered into manufacturing phase and are monitored through international quality assurance and control as it is necessary for ITER project. The workshop building at the French site for the assembly of the cryostat, which is being supplied by India, has been completed and was formally inaugurated. Various other R&D activities necessary are being done at ITER-India laboratory here in IPR campus, which will then be transferred to the construction site after due approval.

At the Centre of Plasma Physics (CPP) , Guwahati the development of a neutron source based on inertial electrostatic confinement fusion scheme and its application in damage study of fusion materials is progressing well. Dusty plasma experiments, divertor simulation study experiments etc are some of the other activities which are progressing as per plan. Theory and simulation works in the centre are also progressing well.

Director,  
IPR.



# ANNUAL REPORT

**APRIL 2014 TO MARCH 2015**

*Since 1986 the institute has been excelling in plasma physics research with fast growing facilities, trained man power and many fruitful national and international collaborations. Started with small tokamak experiments and basic plasma experiments, the institute has been acquiring expertise in all the relevant scientific and technological requirements for controlled thermonuclear fusion. Through the participation of the country in the ITER project, the developed technologies are being tested in the international arena. The activities of the Fusion Technology Development Programme under the past and current Five Year Plans are progressing and fuelling the required growth. Also the programme at Center of Plasma Physics, Guwahati has been well integrated with the main chapter. The plasma technology dissemination to industry through Facilitation Center for Industrial Plasma Technology (FCIPT) has become a routine part of the programme.*

## CHAPTERS

A. SUMMARY OF SCIENTIFIC & TECHNICAL PROGRAMME .....	01
B. ACTIVITIES OF OTHER CAMPUSES .....	42
C. ACADEMIC PROGRAMME .....	55
D. TECHNICAL SERVICES .....	55
E. PUBLICATIONS AND PRESENTATIONS .....	55
ANNEXURE -I Outreach Programme for Public Awareness.....	55
ANNEXURE -II Representation of SCs, STs & OBCs.....	55





## ***CHAPTER A***

# **SUMMARY OF SCIENTIFIC & TECHNOLOGICAL PROGRAMMES**

A.1 Fusion Plasma Experiments .....	02
A.2 Fusion Technology Developments .....	12
A.3 Basic Plasma Experiments .....	28
A.4 Theoretical, Modelling & Computational Plasma Physics .....	35

## A.1 Fusion Plasma Experiments

There are two existing facilities in the institute to do experiments related to fusion plasma, namely Aditya tokamak and Superconducting Steadystate Tokamak-I (SST-I). In this section the status of the device, new developments and details about the experiments done are given.

### A.1.1 Aditya Tokamak

A.1.1.1 Status of the Device & Experimental Results .....	02
A.1.1.2 Diagnostics Developments .....	03
A.1.1.3 Heating Systems .....	03
A.1.1.4 Aditya Upgrade .....	04
A.1.2 Steady-state Superconducting Tokamak(SST-1)	
A.1.2.1 Status of the Device & Experimental Results .....	05
A.1.2.2 Diagnostics Developments .....	07
A.1.2.3 Heating and Current Drive Systems .....	08

### A.1.1 Aditya Tokamak

#### A.1.1.1 Status of the Device & Experimental Results

In the reported period plasma discharges of maximum plasma current of  $\sim 160$  kA and discharge duration beyond  $\sim 250$  ms with plasma current flattop duration of  $\sim 140$  ms were obtained. This was done with negative converter operation and such long discharges were obtained for the first time. The toroidal magnetic field was raised up to 1.26 T to maintain edge safety factor ( $q$ )  $\sim 3$ . The best base vacuum of the order of  $\sim 3 \times 10^{-8}$  torr has been achieved after successfully baking

*Aditya is the first indigenously built tokamak in the country and is operational since 1989. It has produced more than 100 internationally reputed journal publications and 9 Ph.D. theses.*

of Aditya vacuum vessel up to  $110$  °C. The minimum loop voltage of  $\sim 1.6$  V is achieved in many shots during plasma current flat top. Improved discharges are attempted over a wider parameter range to carry out various confinement scaling experiments. In these improved discharges, chord-averaged electron density  $\sim 3.0 - 4.0 \times 10^{19} \text{ m}^{-3}$  using multiple hydrogen gas puffs, plasma temperature of the order of  $\sim$

$500 - 700$  eV has been achieved and maintained till the end of the discharges. Encouraging results from other experiments (LHCD, radiative improved confinement mode (RI mode) with Neon (Ne) Gas puff, 2nd harmonic 42 GHz ECR experiment, 30 MHz ICR heating experiment with Aditya Pulsed Power Supply (APPS) operation has also been obtained.

*Gas puff induced Radiative Improved (RI) modes Experiment:* Neon gas puffs were introduced from the bottom port (single as well as multiple) at different time intervals. It was observed that the density and temperature increased showing an improved confinement behaviour along with the increase

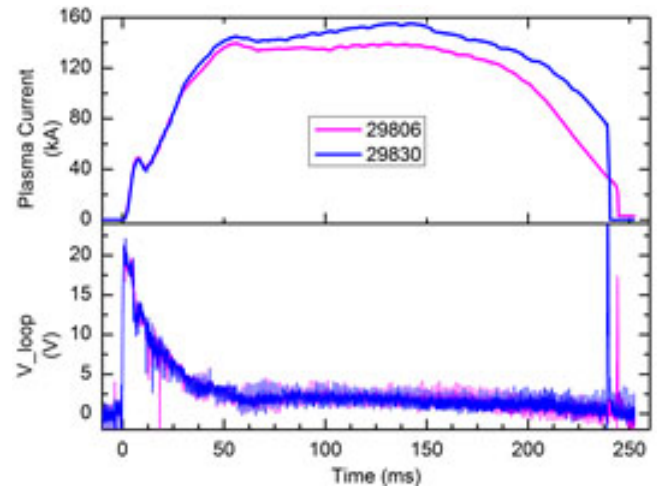
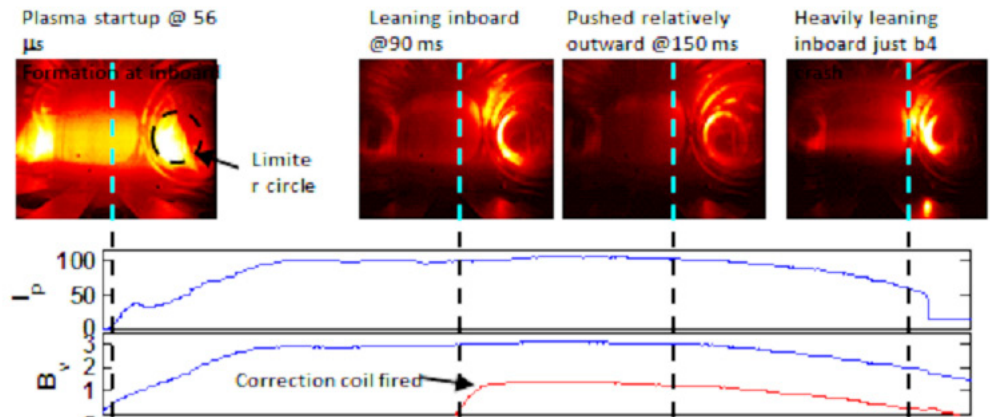

Figure A.1.1.1. Top and bottom runaway coils

Figure A.1.1.2 Wide angle panoramic view of tokamak from radial port. Data acquired at 14 kHz, consecutive frames are 71 microseconds apart. Entire poloidal cross section including limiter is within the field of view of camera



in the radiated power. This indicates a better particle and energy confinements with Ne puff.

**Edge Turbulence Studies by Fast Visible Imaging:** In Aditya tokamak, electron cyclotron resonance heated (ECRH) Ohmic plasmas have been investigated by two dimensional tangential fast imaging techniques. Excellent images at high spatial and temporal resolution were obtained. Intermittent strong fluctuations dominated by blobs at the edge and Scrape-Off-Layer region are being investigated using these images.

#### A.1.1.2 Diagnostics Developments

**Spectroscopy Diagnostics:** Photomultiplier tube based filterscope systems are routinely operating on the Aditya tokamak, along with a wide variety of spectrometers. During last year, an attempt was made to access the higher discharge parameter regime by increasing the toroidal magnetic field and thereby sustaining higher plasma current. As a consequence higher plasma densities are achieved. Two fast visible imaging systems are installed at radial ports on Aditya to capture the evolution of plasma at a high frame rate (frames per second; fps). Fig. YY shows the snapshots of the plasma shot #28816 at two different time instances- the initiation of plasma and the well confined plasma cruising through the flat-top phase of the plasma current. Such high speed ( $1k < \text{fps} < 90k$ ) imaging capabilities enable us to perform studies of plasma edge turbulence as well as monitoring specific events like displacements of the plasma column, plasma wall interactions, formation of hot spots etc. during a plasma shot.

**Probe and Bolometer Diagnostics:** The stored diamagnetic energy, WDIA was measured for saw-teething (ST) and non-

saw-teething (NST) Aditya discharges. The diamagnetic energy was found to be higher in the NST discharges. This could be because of the contribution of non-thermal particles in WDIA measurements. The radiation power loss PRAD was also studied for these discharges and it was found that PRAD was higher for ST discharges. This indicates that ST discharges may have high impurities at the plasma edge as bolometer measures radiation contribution from impurities. The WDIA increased with increasing input power in ST discharges the ratio WDIA/PIN may give the energy confinement time.

#### Charge Exchange Neutral Particle Analyzer (CX-NPA):

The diagnostics aims to measure the core ion temperature of plasma in Aditya as well as in SST-1 based on its passive mode of operation. It uses retarding electrostatic field to separate the energy components of the CX- neutrals (ionized after its exit from stripping cell) escaping from plasma.

#### Infrared Thermography (IRT) of Plasma Facing Components:

IRT of Plasma Facing Components (PFCs, namely Limiter, Diverter, stabilizer plates etc.) is one of the most essential tools to investigate plasma-surface interaction and to estimate power loss through this interaction. The information obtained through this diagnostic is useful for machine protection, plasma control and for physics studies. Statistical analysis showed typical power loss due to limiter-plasma interactions and the results can be useful for power balance studies. The IRT system is deployed on both the tokamaks ADITYA and SST-1.

#### A.1.1.3 Heating Systems

**Lower Hybrid Current Drive (LHCD) Experiment:** With a

specially designed gas puff manifold installed near the electron side of the LHCD antenna at radial port No. 13, enhanced coupling of LH power was observed. The experiment shows increase in the edge density near LH antenna and considerable reduction in the reflection co-efficient. Discharges with duration  $\sim 180$ -210 ms have been achieved in presence of LHCD, whereas in absence of LHCD, all the discharges were terminated  $\sim 150$  ms.

**ECRH Second harmonic Heating Experiment:** The gyatron based Electron Cyclotron Resonance Heating (ECRH) system (42 GHz frequency and 500 kW power) has been used to assist the breakdown and start-up in the Aditya tokamak. This is based on second harmonic resonance ECRH.

**Ion Cyclotron Resonance Heating (ICRH) Experiment:** The heating experiments at second harmonic with 1 MW RF generator in the frequency range of 20-40 MHz, were carried out using RF pulses of different magnitudes (5 ms-100 ms) at different RF powers (40 kW-200 kW) in plasma duration of 100

*Plasma current of as high as 160 kAmp and temperature well above 5 million degrees were obtained for almost quarter of a second with 1.26 Tesla of toroidal magnetic field. After 25 years of operation, it is going through a major upgrade and is expected to operational by next year*

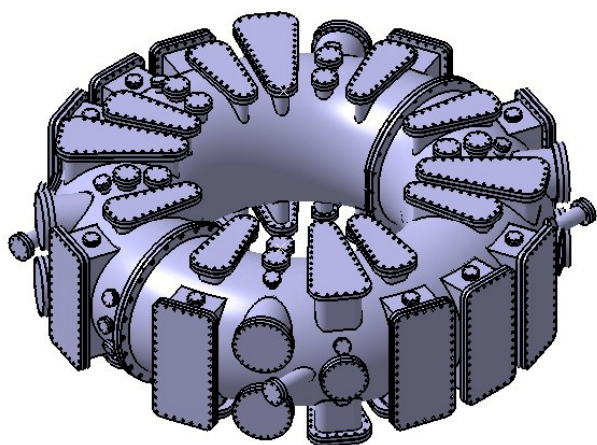

Figure A.1.1.3. Designed Aditya Upgrade Vacuum vessel with circular cross-section. Before it was with rectangular cross-section

ms. These experiments showed rise in ion temperature during ICR heating power. A new technique was explored to bring back plasma to original state with the help of RF power. In this experiment the disruption of plasma was forcibly produced with the help of gas puff and with the help of feedback control from H alpha signal RF power was introduced to get original plasma current. The experiment was repeated many times in manual as well as automatic feedback mode.

#### A.1.1.4 Aditya Upgrade

The existing Aditya tokamak with limiter configuration is planned to be upgraded to a divertor tokamak with following technical and scientific objectives: (a) Mid-size tokamak with divertor operation and higher duty cycle (b) Test bed for new diagnostics; (c) The students can be trained and (d) Those experiments can be tried out which cannot be carried out in big tokamaks

**Vacuum Vessel:** To accommodate two pairs of new coils (02 at the top and 02 at the bottom) symmetric to the equatorial plane, the existing rectangular toroidal vacuum vessel will be replaced by a new toroidal vacuum vessel with circular cross section. An Isometric view of the new vacuum vessel is shown in Figure A.1.1.3. This vessel is made up of SS 304L in the form of two semi-tori and each semi torus weighs about 750 kg with a wall thickness of 8 mm. This vessel will

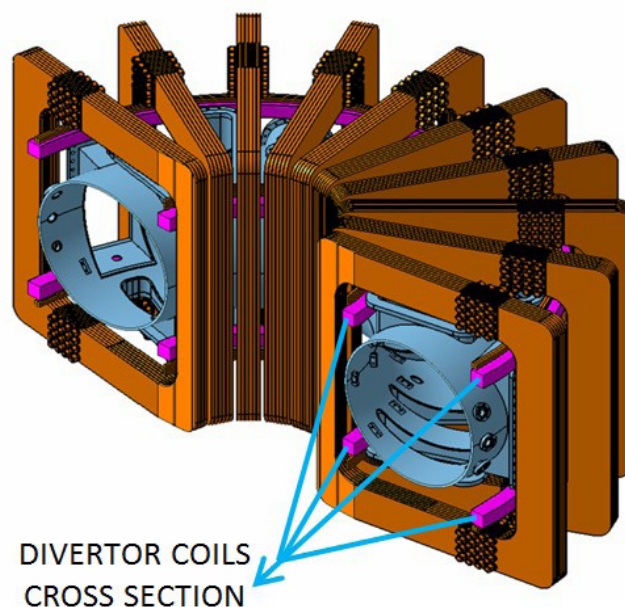

Figure A.1.1.4. Designed Aditya Upgrade Vacuum vessel with circular cross-section.



have 110 nos. of radial, Top and bottom ports of different dimensions.

*Divterter Coils:* The new pairs of coils will be used as diverters. These will be placed symmetrically to the equatorial plane at desired height. The inner pair of will be wound in-situ, after installing all the Inner (big) C-sections of TF coils and before the installation of new vacuum vessel. The outer pair of coils will be installed after installation of new vacuum vessel. The plan for the divertor coils in shown in the figure A.1.1.4 along with the circular cross-section vacuum vessel and with existng toroidal field coils.

*New Buckling Cylinder:* The design, fabrication and procurement of the new buckling cylinder are complete and it is ready for installation.

## A.1.2 Superconducting Steady-state Tokamak (SST-1)

### A.1.2.1 Status of the Device and Experimental Results

Steady State Superconducting Tokamak (SST-1) has made significant progresses in both the physics experiments and up-gradation aspects of its core and auxiliary subsystems during 2014-15. Beginning of April 2014, SST-1 achieved ~ 75000 A plasma current at a Toroidal magnetic field of 1.5 T at the plasma centre assisted with Electron Cyclotron (EC) pre-ionization in fundamental mode. Prior to these achievements, SST-1 has successfully achieved ~ 52000 A of plasma current lasting for ~ 300 ms assisted with EC pre-ionization in second harmonic modes. Subsequent SST-1 experiments saw the ohmic plasma duration in SST-1 being stretched up

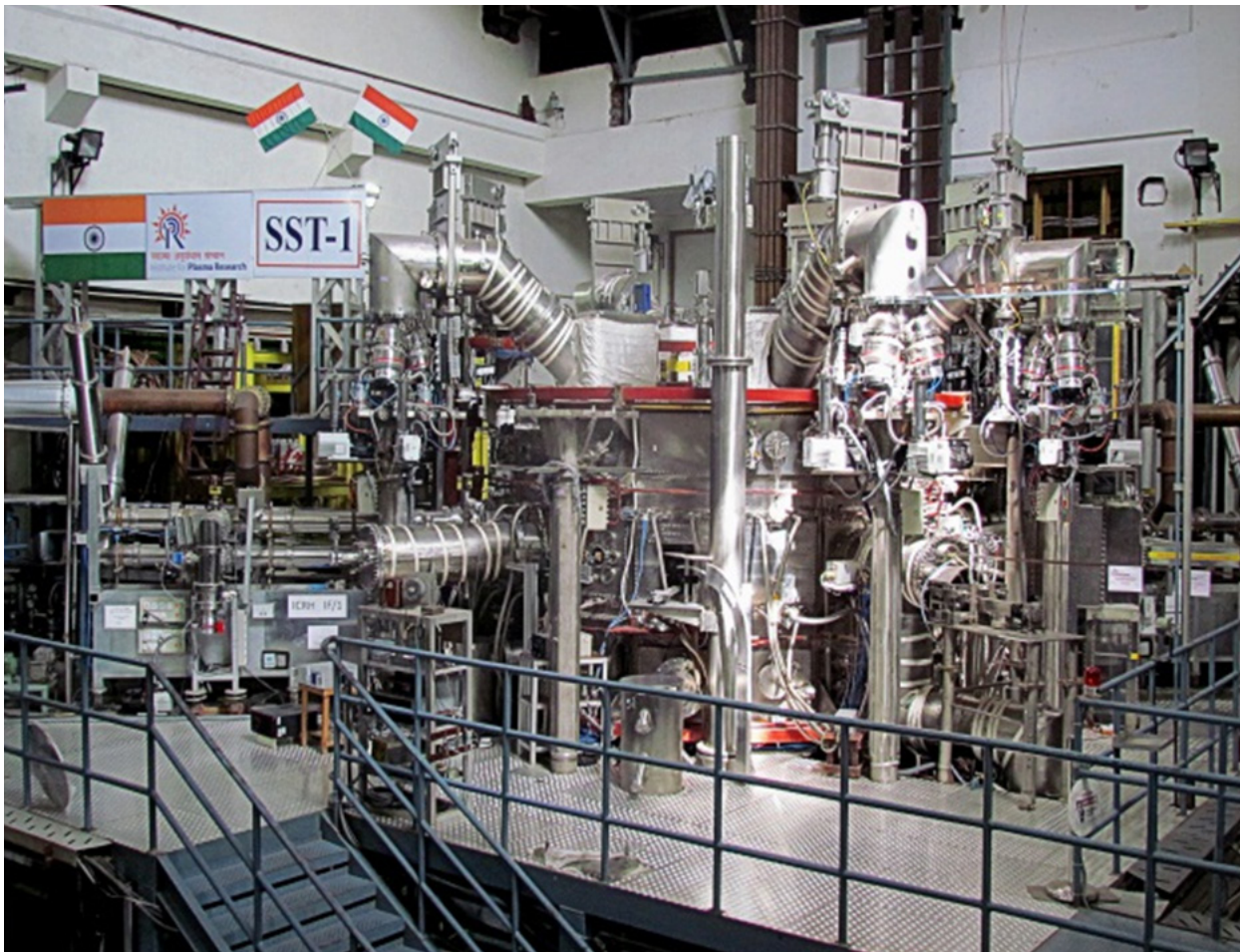

Figure A.1.2.1 Steady State Superconducting Tokamak at IPR

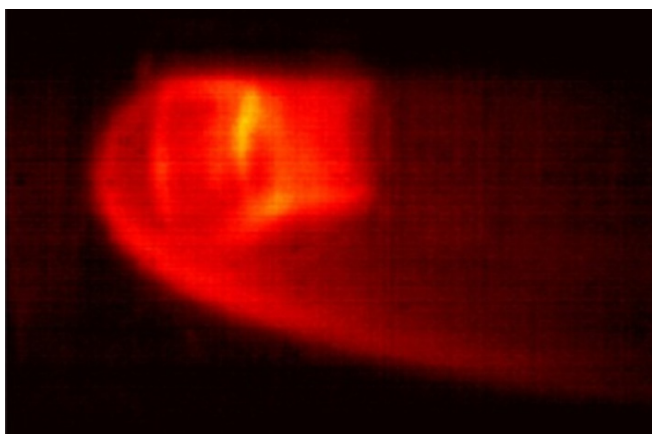

Figure A.1.2.2 SST-1 plasma as imaged

to 500 ms. SST-1 plasmas have been ohmic driven, circular limiter leaning plasma with an average density of  $5-8 \times 10^{18}$  particle per cubic metre and a core temperature  $\sim 350$  eV. These plasma columns are having a minor diameter of  $\sim 0.5$

*SST-1 is a medium size superconducting tokamak, which has been designed and built to study the physics of the plasma processes in tokamak under steady state conditions and to develop technologies related to the steady state operation of the tokamak. SST-1 was the first in the world to demonstrate two-phase helium cooling with cable-in-conduit wound magnets.*

m and major diameter of 2.4 m. SST-1 plasmas shows copious magneto-hydrodynamic (MHD) activities similar to plasmas in other contemporary machines as well as regimes with supra-thermal electrons interacting with a back ground cold plasma column. Further, the confinement scaling in SST-1 closely follows that of the neo-alcator scaling and the Hugill diagrams resembles the same of the contemporary machines at similar stages of operations. Thus, the plasmas in SST-1 have been thoroughly established as calibrated Tokamak plasmas. Additionally SST-1 plasmas have the novel features of being produced with pre-ionizations in both second harmonic and fundamental modes, plasmas successfully getting produced with a low ITER like electric field of  $\sim 0.35$  V/m, non-linear interactions between the seed electrons and the microwave fields explaining the delay in the break-downs,

non-linear tearing modes, island growths and disruptions etc. With these novel features of SST-1 plasmas; 'First Experiment Results of SST-1' were successfully presented in the International Atomic Energy Agency (IAEA) convened Fusion Energy Conference at St-Petersburg on Oct 14, 2014 as an invited oral presentation. This was the maiden occasion that SST-1 has been presented in this prestigious forum under this category.

SST-1 has also achieved several first-of-its-kind feats in the

*The first stage of up gradation is going on with carbon-carbon composite plasma facing components and 80K liquid nitrogen booster system with integrated flow distributions etc.*

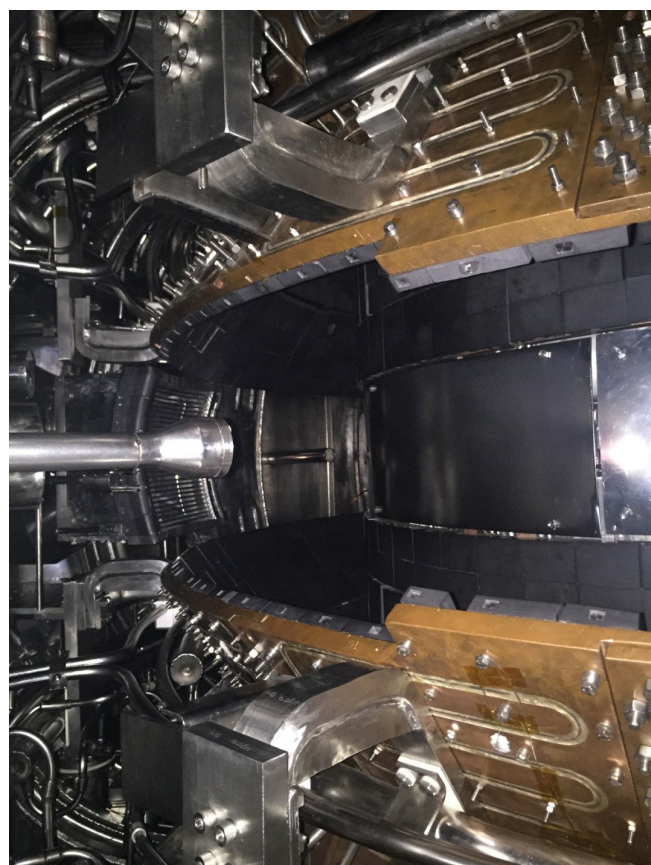

Figure A.1.2.3 SST-1 up-gradation is going on with plasma facing components



technologies front. SST-1 superconducting Toroidal Field Magnets have repeatedly demonstrated cryogenically stable operations over 25000 s being cooled with Two Phase cooled helium during the plasma experiments. SST-1 TF magnets are the only superconducting Tokamak Magnets in the world operating in such optimal cryogenic modes and have possibly offered a unique regime of magnets operations in Tokamaks without the apprehended thermo-acoustic instabilities in cable-in-conduit-conductors. Further, reducing the cold (at 5 K) budget further, the vapour cooled current lead communications in SST-1 operates with cold helium vapour at the respective heat exchanger sections instead of liquid helium. Since then, the first stage of up-gradations in SST-1 has been undertaken. The spectrum involves installing the carbon-carbon composite plasma facing components (nearly 4000 3-d profiled tiles) along with their heat sink CuCrZr back plates (~132 in number) weighing total in excess of 5000 kg [figure A.1.2.3], up-grading the hot nitrogen baking systems for the plasma facing components, re-calibrating the 5 K helium refrigerator liquefier system to its design specifications, integrating the 80 K Liquid Nitrogen Booster system to SST-1 with integrated flow distributions, designing and developing a supersonic molecular beam injection system with enhanced efficiencies of gas fuelling into the SST-1 plasma, extending the data acquisitions to multi second domains, introducing feedback and controls on the plasma current and densities etc. Few plasma diagnostics would also be added onto the SST-1 device. These up-gradation tasks are expected to be completed soon. These up-gradations would further take

SST-1 closer to its contemporary superconducting Tokamaks and would prepare the device for long duration discharges. After that, the up-graded SST-1 has been envisaged to undergo another round of engineering validations followed by plasma physics experiments

#### A.1.2.2 Diagnostic Developments

*Reciprocating Langmuir Probe Diagnostic:* A Reciprocating Langmuir Probe Drive has been installed for testing at the bottom port 10. It is designed for the measurement of SOL temperature and density in SST-1. The probe head consisting of an array of Langmuir probes will be moved across the SOL at the rate of 1m/s scanning a length of 200 mm in 200 ms. The movement is achieved by two pneumatic drives. The slow drive moves the probe head by around 200 mm to a reference position where the system stays for the whole duration of experiment. The fast drive moves the probe head from the reference position and takes it through the SOL during the discharge duration. After the discharge, the probe head is moved back to its reference position. The reciprocating probe drive is controlled through Programmable Logic Control (PLC). The PLC will get an external trigger from the loop voltage. With a settable delay the programmable scans would start. The number of scans and the time interval between them are programmable. As per the program settings PLC would initiate and execute the scans. During the plasma shot any number of scans can be taken with equal or unequal duration of time interval, as per the requirement.

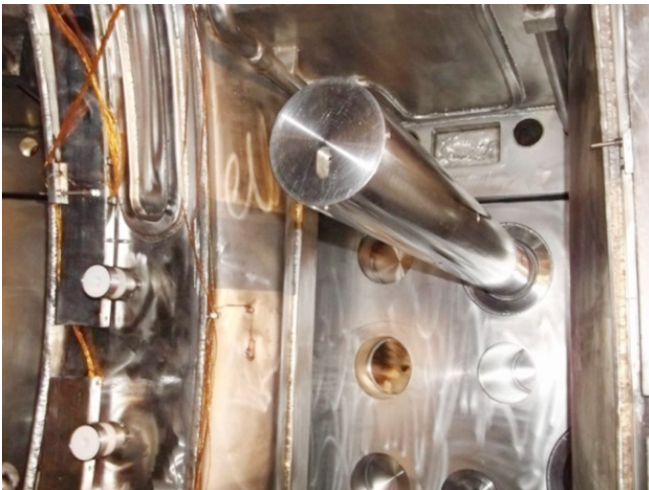

Figure A.1.2.4 Bolometer Camera as seen from inside of the SST-1 vacuum vessel

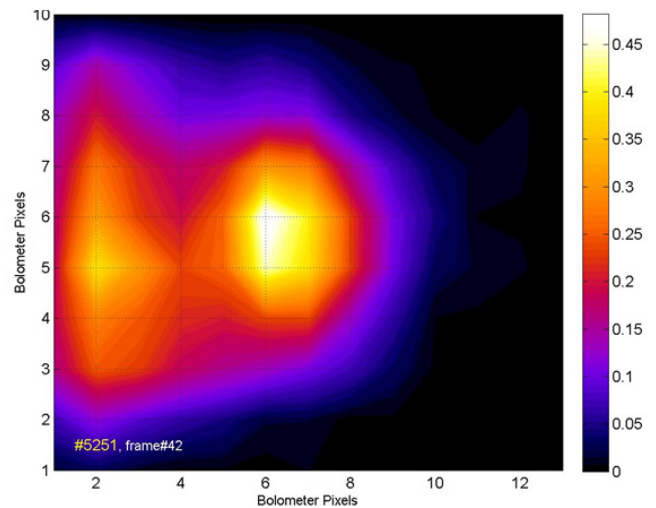

Figure A.1.2.5 Experimentally obtained temperature profile on the InfraRed Video Bolometer foil

*Bolometer Diagnostic:* The radiation power loss PRAD in SST-1 is measured using array of AXUV photodiodes. One out of the designed seven bolometer cameras has been installed on radial port no. 15 in SST-1 for measurements from limiter plasma discharges. The camera is placed inside the SST-1 vacuum vessel and it images the plasma via a pinhole. The signal from the array is taken out of the vacuum vessel through an electrical feedthrough and is fed to the amplifiers mounted close to the radial port. The radiation power loss was measured for all plasma discharges in SST-1. It was found to vary from 30% to 50% of the input power.

*While a lot of experiences have been gained through operating various diagnostics for Aditya tokamak, translating those experiences to a steady state machine like SST-1 is very challenging. Those challenges have given many more valuable experiences to the scientists working here*

*Spectroscopy Diagnostics:* Visible spectroscopic diagnostics on SST-1 was upgraded by adding 8-channel Photo Multiplier Tubes array based diagnostic to carry out space resolved measurement of H-alpha and carbon CIII (C2+) emissions. By exploiting the line intensity ratio of C2+ emissions, electron temperature ( $T_e$ ) in the range of 15 to 30 eV was estimated. These values reflect the  $T_e$  of the plasma region where C2+ ions are residing.

*Infrared Imaging Video Bolometer (IRVB):* It is an “imaging-bolometer” that provides 2D temporally resolved total radiated power profile from plasma and using inversion tomographic technique, re-construction of radiation structure from plasma can be determined. The technique utilizes a free standing ultra-thin metal foil having large lateral area, which absorbs radiated power from plasma through the pinhole camera geometry typically in wide spectral range (SXR to IR). This absorbed power by foil raise its temperature that actually corresponds to integrated projection of radiation source inside the plasma. The 2D temperature profile of the foil is remotely imaged and measured by the Infrared Camera seating outside the vacuum vessel through IR-transmitting vacuum view port. Applying 2D heat diffusion analysis of temperature data, total radiated power from plasma can be

determined. Also first signals of IRVB system deployed on the SST-1 Tokamak were obtained during the experimental campaign-IX. The expected signal level in the SST-1 tokamak is found to be very small, that imposed challenges in designing the diagnostic. Reasonable agreement found between modeled IRVB image and experimental image from the IRVB installed on the SST-1 tokamak.

*Detection of synchrotron radiation emitted by “Runaway Electrons” using IR-Camera:* “Runaway Electrons” (REs) are produced inside the tokamaks during different phases of a plasma discharges based on experimental conditions and plasma parameters. These REs are high energetic electrons typically in mega electron volts (MeVs). Experimental observations and detection of Runaway Electrons (REs) is very important for many reasons namely physics studies, machine protection and plasma control for mitigation of RE generation. Several active and passive diagnostic methods are available for the detection of confined and de-confined REs. One of the established method is HXR monitor. However, this method is indirect and estimation of REs confined current is difficult and requires certain assumptions. Another interesting and quite established method is detection of synchrotron radiation (which typically fall in infrared range/visible range) emitted by REs when they are still confined inside the plasma column. Infrared Camera can detect forward synchrotron emission from REs, if the camera is configured in electron approach tangential viewing direction.

### A.1.2.3 Heating and Current Drive Systems

Being a steady state and superconducting coils machine, SST-1 requires radio frequency heating and current drive systems for its regular operation. ECRH for plasma preionization, LHCD for long duration plasma current drive along with ICRH for heating and profile control are very important for the machine operations. Apart from these heating systems, SST-1 will have a neutral beam injection heating system also.

### Electron Cyclotron Resonance Heating System

The 42GHz-500kW ECRH system has been emerged as a key system for SST-1 tokamak. The system has been used to carry out ECRH assisted plasma breakdown, start-up and current drive experiments at fundamental and second harmonic frequencies. With toroidal magnetic field of 1.5T ECRH power (~up to 300kW) in fundamental O-mode is launched from

low field side of tokamak. The power is launched around 20ms before the loop voltage. The consistent breakdown assisted with ECRH is achieved in SST1 tokamak with longer shots with plasma current up to  $\sim 70$ kA. When the SST1 tokamak is operated at 0.75T magnetic field, the 42GHz system is used and second harmonic ECRH assisted breakdown experiments are carried out over wide range of tokamak parameters. Approximately 250 to 300kW ECRH power is launched in X2-mode and ECRH pulse duration is varied from 125ms to 450ms. Since there is delay in second harmonic ECRH assisted breakdown, it is launched around 50ms before the loop voltage. The successful second harmonic ECRH assisted breakdown has been achieved in SST-1 at 0.75T operation.

*ECCD and long pulse ECRH operation in SST-1:* In order to ensure the effect of ECRH on plasma current, ECRH is used for longer duration. From this experiment, it is ensured that ECRH contributes/support plasma current, which is an additional feature of ECRH in SST-1. In order to achieve this a metallic SS304L reflector is installed at angle to inboard side of tokamak. It provides an additional momentum to electron to support plasma current.

*15A RHVPS for ECRH:* The 80kV-15A regulated high voltage power supply (RHVPS) dedicated to ECRH has been commissioned successfully with Gyrotron. The ECRH system with new power supply has been tested for 350kW of power for 500ms duration. The recent experiments on SST-1 has been carried out with new RHVPS. This effort facilitate to use 75A power supply to LHCD system for higher power operation in SST-1.

### Lower Hybrid Current Drive (LHCD) System

With two klystrons in operation, feeding layer-1 and layer-2 of the LHCD system, LH power is successfully launched in SST1 machine, during campaign-XI (Sept-Oct., 2014). In this configuration, the LH power is launched from the bottom row of the grill antenna. During the experiments  $N//$  is varied from 2.25 to 3.25 and LH power of up to 175 kW is launched in to the plasma. Immediate response to LH power is observed in CdTe detector signal indicating interaction of lower hybrid waves with plasma and generation of suprathermal electrons. The experiments are performed at toroidal magnetic field of 1.5T. Preparation of the LHCD system for the next campaign has been initiated. For the coming campaigns, with PFC components with baking up to 350 °C, the

LHCD system is being made compatible for the high baking temperature environment. The SS grill antenna with active water cooling has been fabricated. The old copper grill which had developed leaks in water cooling line has been removed from SST1 machine and is replaced by newly fabricated SS grill. All the cooling line connections have been made and weld joints are QAQC qualified. Simulation studies have been carried out which confirms that our design would maintain the seals at reasonable temperatures and maintain it in-

***For SST-1, all the three types of Radio-Frequency based heating and current drive systems ECRH, ICRH and LHCD are operational now.***

tact during high temperature baking with grill and vacuum window actively cooled. However, as a back-up plan, new (Viton and Kalrez) seals have been procured and would be replaced immediately, if the existing seal fails to meet the challenging high temperature environment during baking. Temperature sensors are put near the seal region to monitor the temperature during baking. To feed more LH power in the coming campaign, preparations for connecting layer-3 and layer-4 to grill antenna is in progress. The integration of other two klystrons output to the input line of layer-3 and layer-4 is also in progress. All the four klystrons are now put on its respective klystron tank. Each of the klystron is individually tested for its electrical connections and conditioned for high power operation. Now preparations are being made to connect all the four klystrons in parallel configuration so that all the four klystrons may be operated simultaneously through single high voltage power supply. Two anode modulator power supplies (each connected to two klystron system) are used to control four klystrons simultaneously during parallel operation.

### Ion Cyclotron Resonance Heating System

Mega Watt level RF power is being planned to introduce in SST-1 machine to increase its temperature from 1 keV to 2 keV for which MW level RF generator is built indigenously. The integration of antenna and interface on both the ports along with the installation of one set of diagnostics near each port has been completed. It was decided to open port no. 6 for repair of the bellow which was blocked to avoid leak.

The complete antenna and interface was dismantled, new bellow was installed after leak testing, remaining two sets of diagnostics were installed and the system was made ready for SST-1 operation except the last top bellow section which has to be installed after leak testing of SST-1 vacuum vessel.

*Development of IGBT based HV switch instead of crow bar system:* Conventional power supplies need crow bar system to protect high power rf tubes from damage during fault. However every crow bar action short circuits the power supply and therefore the life of power supply decreases. Instead one can have very fast high voltage switch to isolate the power supply during fault and hence one can protect the tube as well as avoid damage to the power supply. It is planned to go ahead in steps to increase the voltage capacity as well as current capacity. In first phase, the design of 4kV, 1A series connected IGBT switch for Triode based ICRF amplifier protection is developed after detailed simulation. Simulation model of 4kV, 1A series IGBT switch developed in PSIM software for adjustable switching jitter among different devices for optimization of voltage rating. The switch is tested for 4 kV and is found that it operates in less than 10 microseconds.

### Neutral Beam Injection (NBI) Heating System

The first combined operation of Plug-In-Neutral-Injector (PINI) and an assembly of two indigenously developed cryo-condensation pumps (figure A.1.2.6) has been done. These pumps are operated by using liquid helium at 4.2 K in the pump and by flowing liquid nitrogen in the radiation (thermal) shields. The experiment on the combined operation of cryopumps and PINI was conducted to primarily assess the performance of pumps, and to manage the pressure gradients in the beamline. The experiment was planned for handling the significantly high values of gas feed required for operating the ion source and as well as achieving a safe regeneration of the cryopumps after the operation. The effective pumping speed of the two cryopumps was measured to be about  $4 \times 10^5$  l/s. At the same time, the ion beam of 18 A with the energy upto 40keV was extracted. Typical thermal footprints (using IR camera) for the ion beam obtained during recent PINI operations are shown in figure A.1.2.8. The whole NBI system was tested for high gas feed rates of hydrogen into the ion source (upto 30 torr-l/s) and for gas feed into the neutralizer (upto 80 torr-l/s) while keeping the desired pressure profiles along the beam line. The neutralizer and beam line pressure were kept in the range of  $10^{-3}$  torr and  $10^{-5}$  torr respectively.

To improve the operation parameters a suitable modification is proposed for the control system of ion source which shall be soon incorporated in its operation. Fabrication of transition components, shine through armor and beam transmission duct, (required for integration of NBI with SST-1) is in progress and are expected to be delivered soon (figs. A.1.2.7

***The NBI heating system is getting ready to get integrated by next year.***

and 9). Design for assembly of NBI at SST-1 is completed and the procurement process is in progress (figure A.1.2.10). The assembly and integration of NBI with SST-1 is expected to be completed this year.

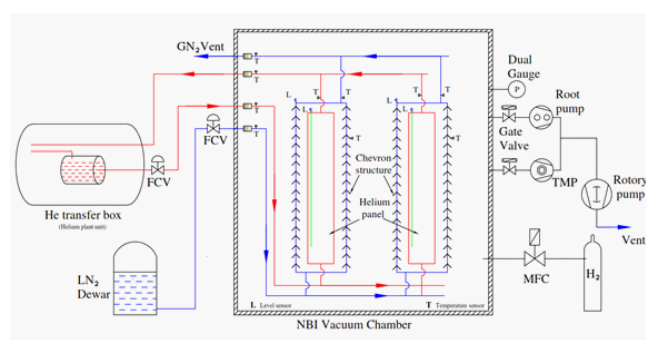

Figure A.1.2.6 Schematic of the experiment on the assembly cryo condensation pumps



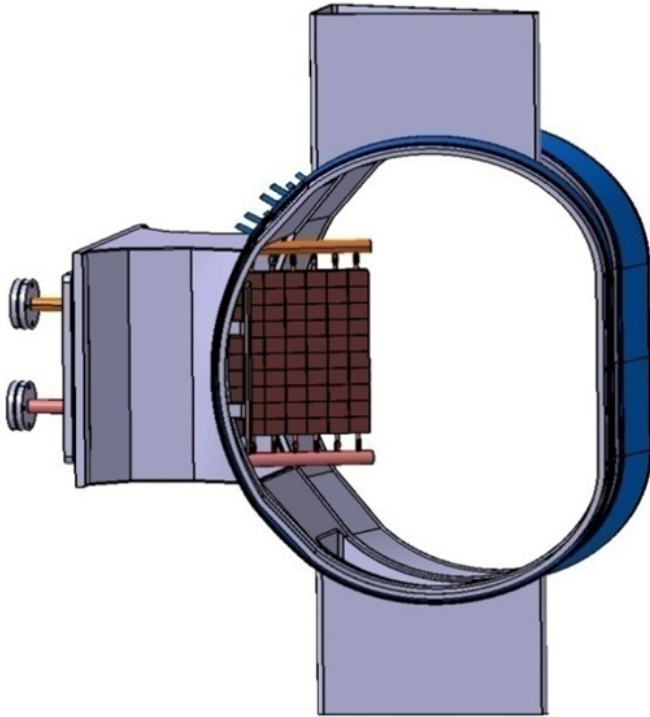

Figure A.1.2.7 3D view depicting the shine-through Armor

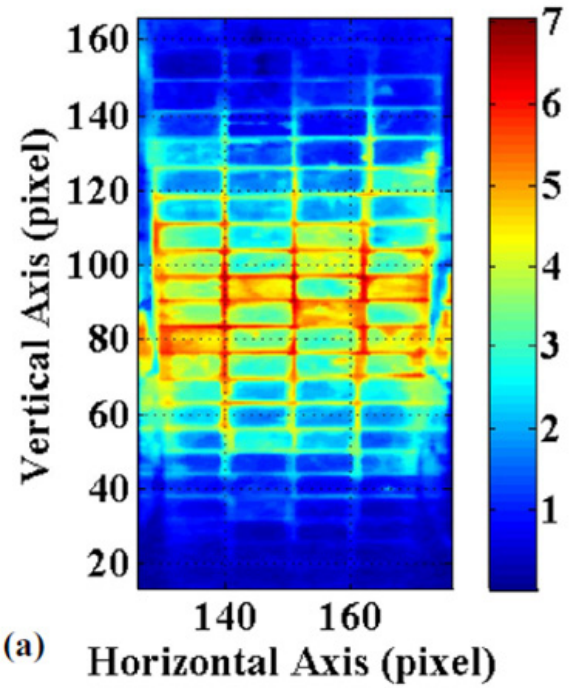

Figure A.1.2.8 Beam Footprints using an Infrared camera

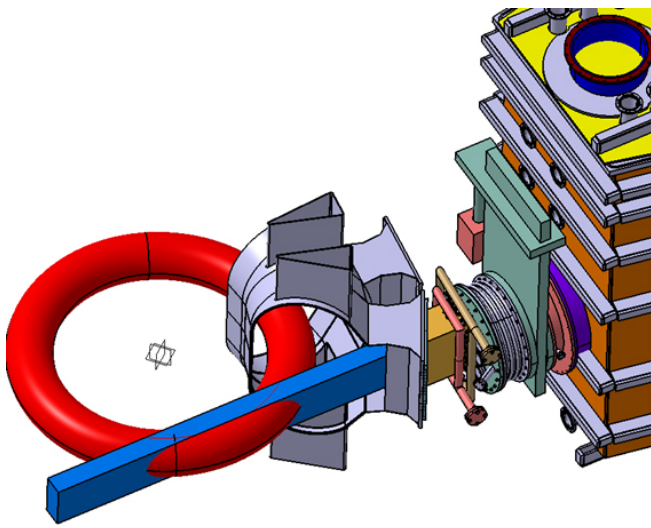

Figure A.1.2.9 3D view depicting the assembly of beam transmission duct and beam injection geometry

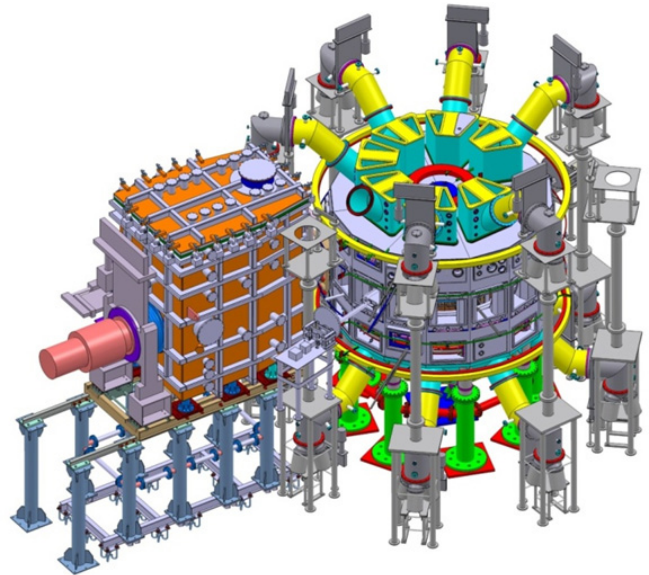

Figure A.1.2.10 3D view depicting the assembly of Neutral beam injector in SST1 tokamak

## A.2 Fusion Technologies Development

Under Continuing five year plans, various technologies related to fusion are being developed under the following heads :

A.2.1 Magnet Technology.....	12
A.2.2 Divertor & First Wall Technologies.....	14
A.2.3 Cryo-pump Development .....	16
A.2.4 Test Blanket Module (TBM) .....	17
A.2.5 Large Cryogenic Plants & Cryo-systems (LCPC).....	19
A.2.6 Remote Handling & Robotics Technology.....	21
A.2.7 Negative Ion Neutral Beam System.....	23
A.2.8 Fusion Reactor Materials Development & Characterization.....	25
A.2.9 Fusion Fuel Cycle.....	26

Brief details about the progress made in the report period is given in this section.

### A.2.1 Magnet Technology

This programme caters to the development of different magnets which will be used in a fusion machine. The various initiatives for manufacturing and testing of superconducting

***Magnet technology is one of the important requirements for the magnetically confined tokamak plasmas. Apart from catering to domestic experiments, this activity is collaborating internationally also for e.g. ELM coil of JET which is a big tokamak at Oxfordshire, UK***

magnet have been aggressively pursued along with development of required facilities and technologies.

*Manufacturing of casing for both type of ELM coils along with optimization of its encasing methodology:* The ELM coil is to be designed and fabricated under the collaboration programme with Joint European Torus (JET) machine at United Kingdom. The winding pack has been manufactured using

special purpose winding machine within tolerance of  $\pm 3$  mm. The Inconel 625 casing for both type of ELM coils has been fabricated as per dimensional requirements and its tolerances. The ultrasonic testing procedure has been established for casing weld joints. The encasing activities of winding pack following its vacuum pressure impregnation is under progress.

*Development and optimization of vacuum pressure impregnation process along with required facility for ester based high temperature insulation of ELM coil:* Vacuum pressure impregnation (VPI) procedures for indigenous ester based high temperature insulation appropriate for ELM coils are being developed through collaboration with Indian industries. The VPI process and its optimization have been qualified with extensive trials on long length arrays of ELM winding pack. The insulation after VPI has been characterized for its mechanical and electrical characteristics. The required facilities, as shown in Figure A.2.1.1, for vacuum pressure impregnation have been developed and demonstrated on equivalent demonstration coil. The VPI of both type of ELM coil is under progress.

*Design, Development and R&D for SST-1 Superconducting central solenoid employing  $Nb_3Sn$  based CICC:* Under SST-1 technological up-gradation activities, the initiative has been taken for design and manufacturing of central solenoid

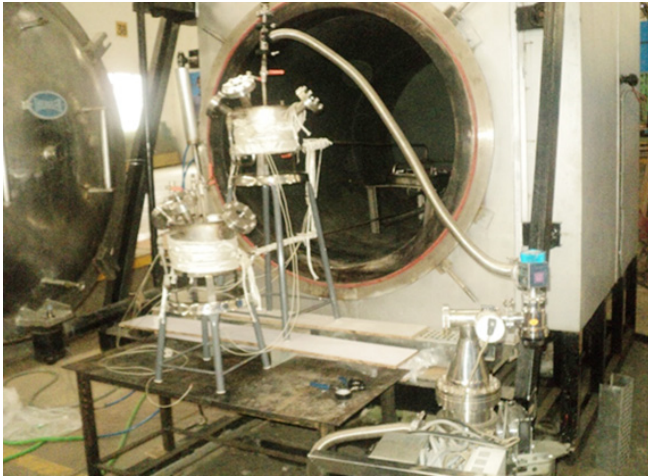

Figure A.2.1.1 Facility for vacuum pressure impregnation (VPI)

employing  $Nb_3Sn$  based cable in conduit conductor (CICC). The design of CICC and configuration of winding pack for central solenoid has been completed and reviewed by subject experts. The required R&D (Heat treatment of strands, VPI of CS, spring back of CICC etc.) and prototyping trials

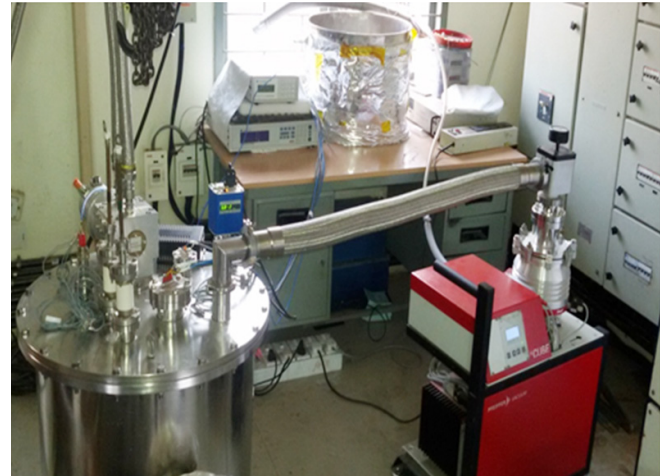

Figure A.2.1.2 Cryogen free facility (Cabling, jacketing and Winding) for manufacturing of superconducting central solenoid are under progress as shown.

*In-house manufacturing of  $MgB_2$  short length strand and  $Nb_3Al$  strand along with development of required facilities for the same:* The initiative has been taken for in-house manufac-

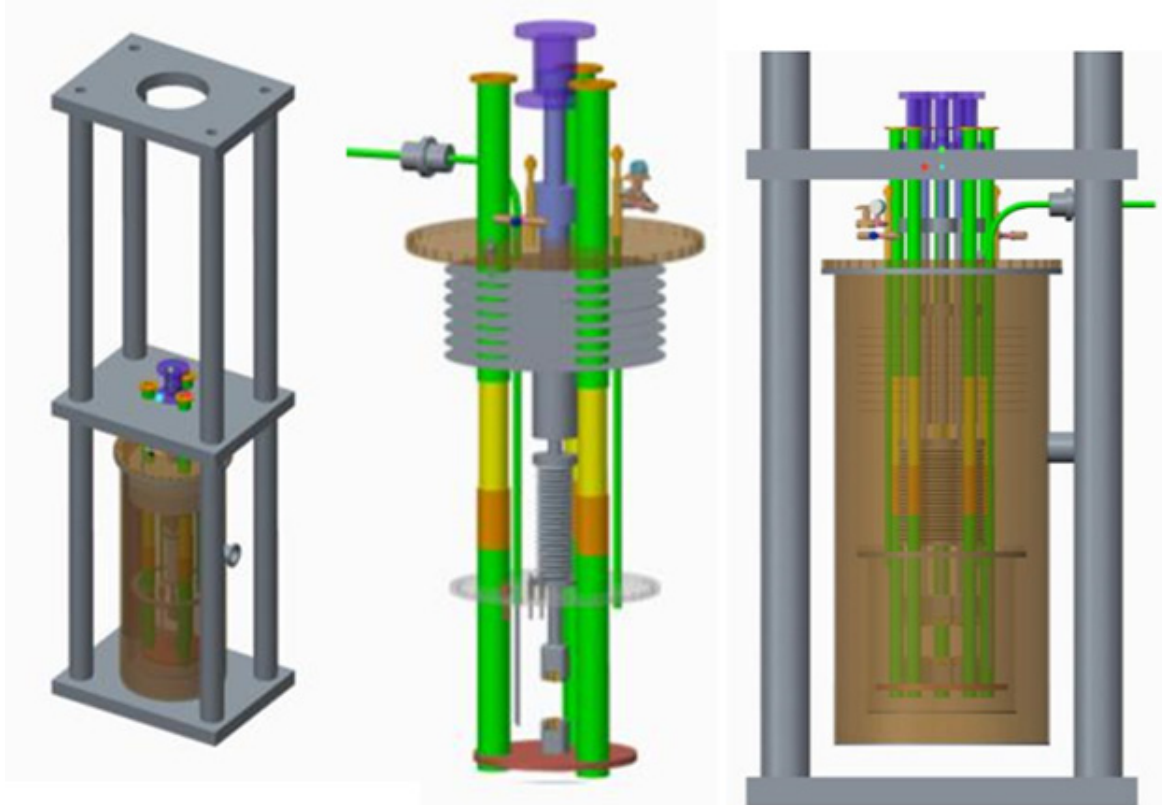

Figure A.2.1.3 . Mechanical characterization facility at low temperature



turing of  $MgB_2$  superconducting strands using power-in-tube approach. The required facilities such as groove rolling machine, extrusion machine and heat treatment furnace has been established. A 100 m long monofilamentary and multifilamentary  $MgB_2$  strands has been indigenously manufactured. The significant progress has been done for development of  $Nb_3Al$  long length strands with Indian industry. The required hot extrusion facility has been developed and demonstrated by successful extrusion copper billets of various sizes.

*Development of cryogen free facility employing pulse tube cryocooler for performance validation of superconductors:* Cryogen free facility consisting pulse tube cryo-cooler, cryostat, Pumping system, Radiation, shield, Current lead assembly, Samples holder and chiller unit has been assembled and validated for its performance. Several superconducting samples of  $Nb_3Sn$ ,  $NbTi$ ,  $MgB_2$ , YBCO, DI-BSCCO has been characterized for their performance validation. The Figure A.2.1.3 shows the cryogen free facility and its cooling trend.

*Development of unique facility for mechanical characterization of materials at 77 K and 5 K:* The initiative has been taken for development and manufacturing of “Mechanical Characterization Facility at Low Temperature (MCFLT)” at the institute. It will be unique facility in India capable of tensile testing, fatigue testing and bend testing at 77 K and 5 K. The feasibility studies and engineering design of MCFLT along with its required system have been completed. The required R&D activities, prototyping trials and manufacturing activities have been started.

*R&D activities for protection aspects of superconducting magnets:* The hybrid circuit breaker with combination of mechanical circuit breaker and IGBTs has been experimentally validated. The auto triggering circuit and function generator to reduce overall operation time for hybrid DC circuit breaker has been demonstrated for 1500 A current. It promises much redundant protection system for large superconducting magnets. The static breaker incorporating series combination of IGBTs has been experimentally demonstrated for 1500 A current operations.

## A.2.2 Divertor & First Wall Technology

This project deals with research and development of the materials & technologies relevant to divertors and first wall components for fusion grade tokamaks. Major activities in the report period are summarized here.

### A.2.2.1 High Heat Flux Test Facility (HHFTF)

*Data Acquisition and Control System for HHF Test Facility:* High Heat Flux Test Facility (HHFTF) is a complex system having many sub-systems, diagnostics and utilities. Data Acquisition and Control System is designed for centralized feedback control of the entire facility and acquisition of data for post processing and analysis. Most of the work related to hardware procurement & testing as well as software design & development has been completed. Integration of sensors and testing of the entire system is currently in progress.

*The High Heat Flux Test Facility (HHFTF) is state-of-the-art facility for material plasma interaction studies which is available in very few places around the world. This helps to decide the armour materials for fusion machines which needs to withstand the extreme conditions prevailing in the edge of the tokamak*

*Electron Beam Profile of HHFTF:* Experiments and Simulations are conducted to estimate the cross-sectional heat flux profile of electron beam of the high heat flux test facility. In order to obtain finer (smaller) beam size, cathode size of electron beam system is reduced from 12mm to 6mm diameter.

*Using the facility:* Experiments on High Heat Flux testing of tungsten alloy mono-block test mock-ups developed by NFTDC (Hyderabad) are continued using this facility. Test mock-ups are tested for 2000 thermal cycles with incident heat flux of  $18MW/m^2$  (absorbed heat flux  $\sim 9MW/m^2$ ).

*Thermal Fatigue Testing of Tungsten materials using HHFTF:* Thermal cyclic testing of three different tungsten materials is performed for 1000 cycles of 20ms ON and 1000ms OFF at energy density of  $\sim 3MJ/m^2$  using HHFTF. Pure Tungsten and Tungsten Alloy with 1%  $La_2O_3$  developed using Direct Sintering Process (DSP) are tested along with Pure Tungsten material. It was observed that pure tungsten materials could successfully withstand all cycles without developing any micro-cracks, whereas, Tungsten Alloy with 1%  $La_2O_3$  developed micro-cracks.





Figure A.2.2.1 Data Acquisition and Control System for High Heat Flux Test Facility

#### A.2.2.2 Other Activities

**Establishment of Abrasive CNC Water-Jet Cutting Facility:** Abrasive CNC Water-Jet Cutting Machine has been installed and commissioned. Soon after its installation, the machine is being used by many groups for precision cutting of a wide variety of materials including Tungsten, CFC (Carbon Fibre Composite), Stainless Steels, Copper Alloys, etc. This machine allows precision cutting at room temperature with minimum wastage and near-net finish.

**Tungsten Materials Development:** GLEEBLE 3800 system is used for development of Pure Tungsten material in the form of a circular disk by Direct Sintering of pure tungsten powder. Tungsten powder of 1-6 Micron particle size is sintered at 1800°C temperature under pressure of 40MPa. Sintered tungsten pallet of 3mm thickness and 14.50mm diameter size is produced with 93% of theoretical density. Necessary fixtures for holding the powder and sintering under pressure are developed using high purity graphite material. Sintered material is further subjected to compressive load for achieving improved density.

**Materials Studies Using Miniature Specimen Techniques:** Miniature specimen testing technique development studies

are performed using Gleeble system. Miniature specimen made of XM-19 material having 14mm diameter and 1mm thickness is fabricated. It is successfully tested for tensile strength at 200°C temperature and 0.01 of strain rate. Fix-

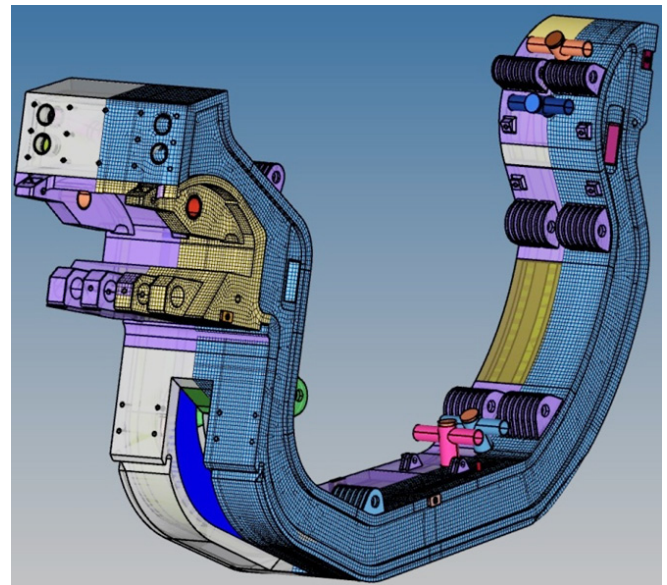

Figure A.2.2.2 Finite Element Mesh Model for engineering analysis of Divertor Cassette Body

tures and specimen are designed and developed indigenously. Controlled Heating of miniature size sample is a challenging task using Gleeble. Parallel heating technique is developed to control heating of the miniature size specimen.

*Engineering Analysis of ITER-like Divertor:* Engineering analysis of the ITER-like divertor are continued including: (a) Computational Fluid Dynamic Analysis to estimate the coolant pressure drop and heat transfer coefficients; (b) Electromagnetic analysis to estimate the eddy current and structural loads induced during off normal events; (c) Thermal-Structural coupled analysis to compute stresses on various parts of Divertor as a result of various thermal and structural loads.

*Electromagnetic Analysis:* Electromagnetic analysis of ITER divertor was carried out to estimate the Lorentz forces due to disruption events in ITER. Two cases were considered for the analysis Major Disruption (MD) 16ms downward (DW) case and 22ms Major Disruption (MD) downward case. The loads on Different regions of the divertor were estimated.

*CFD studies on divertor:* Computational Fluid Dynamic (CFD) analysis was carried out for a single vertical target channel having smooth tube and swirl tape insert tubes. Cold flow analysis as well as conjugate heat transfer analysis is carried out using heat flux of  $5 \text{ MW/m}^2$  in the upper region and  $10 \text{ MW/m}^2$  in the lower region.

### A.2.3 Cryo-pump Development

Fusion Machines require high pumping speed of the order of 2,00,000 liters/sec. But the high magnetic field environment does not allow any commercially available vacuum pump to be useful. Hence the development of Cryo-Adsorption Cryo-pump project is being pursued. Development of such pumps requires special technologies and material development viz double embossed Hydroformed Panels, to be used

*For both, (i) ash and impurity control and (ii) fusion fuel cycle, very high pumping speeds are necessary – around 1-2 lakh liters/second. These pumps are not available in the commercial range, hence needs to be developed indigenously.*



*Figure A.2.3.1 Small Scale Cryopumping Facility (SSCF) developed for testing cryo-pump components*

as cryopanel at 4.5 K (for pumping) and 80K (for radiation shields); High Sorption sorbent to adsorb Helium; Cryogenic compatible adhesive to stick sorbent over panels ; Coating of shaped Cryopanel for emissivity( $\sim 0.9$ ) etc. The development of technologies for double embossed Hydroformed Panels, used for cryopanel at 4.5 K (for pumping) and 80K (for radiation shields) has been done. After successful testing with its entire critical element the technology was transferred to the qualified industry for its industrialization and commercial usage. Development of cryogenic (@4.5K) compatible adhesive to stick sorbent over panels and development of technology for fixing of micro porous activated carbon in dif-

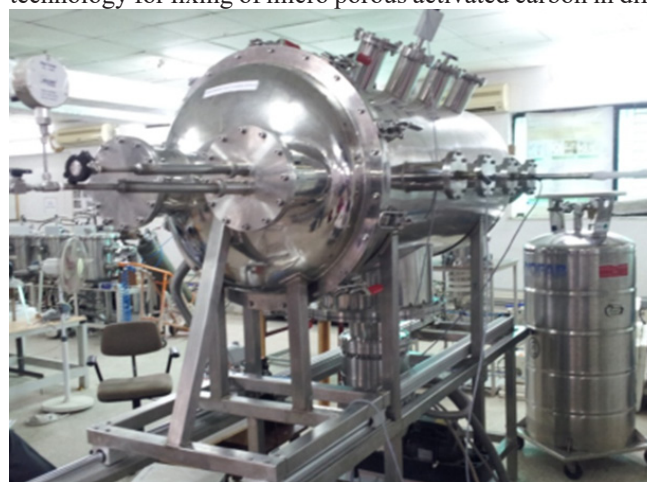

*Figure A.2.3.2 Single Panel Cryopumping Facility*





*Figure A.2.3.3 Multi Panel Cryopumping Facility*

ferent forms on prototype panels was taken up and successfully completed with industrial support and other research organizations. For a quality validation of all the indigenous technologies a prototype experimental test facility “Small Scale Cryopumping Facility (Pumping Speed 2000 l/s)” were established and studies were carried out as per International Vacuum Standard. In continuation with the above facility “Single Panel Cryopumping Facility” was established to demonstrate the cryopump and its pumping capability. Pumping speed of ~10000 l/s was successfully demonstrated and were presented and accepted by the national experts. Finally, for the physics and engineering validation and to deliver the required pumping speed as mentioned in the XI-plan project Multipanel Cryopump were established and successful tests were performed to achieve the final delivered pumping speed of ~50000 l/s. These pumps are shown in the figures.

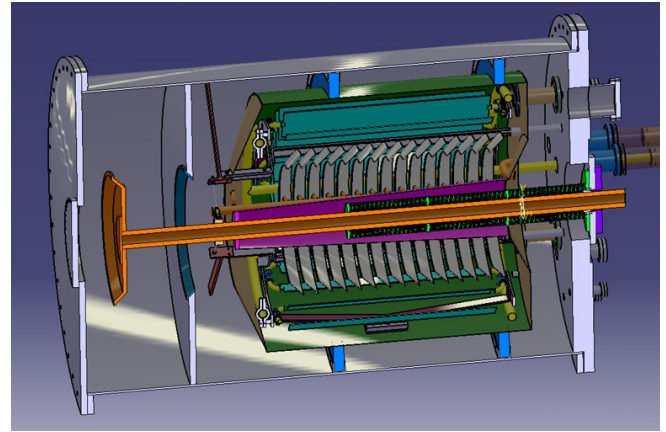
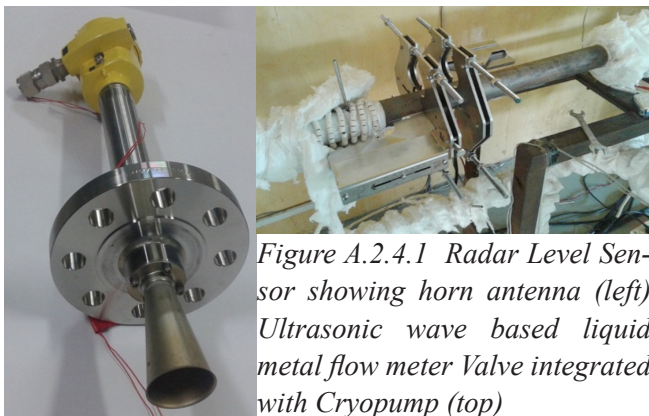

*Figure A.2.3.4 Valve integrated with Cryopump*

*Development of cryo-pump valve:* Valve is a component which isolates two vacuum systems at different pressure or vacuum levels. The quality of valve depends upon the allowable leak rate through valve when it is in closed condition and also the life time of valve. A special kind of huge valve is being developed in India for cryopump application. The advantage of this valve is that, it occupies very less space in comparison to conventional valves available commercially. Most of the components of valve will be indigenously developed. A significant work towards conceptualization and benchmark experiments has been carried out. Various experimental systems have been developed for component level testing.

#### A.2.4 Test Blanket Module (TBM)

The Indian Lead-Lithium Ceramic Breeder (LLCB) TBM systems design and development activities has made considerable progress during the report period. The Indian Test Blanket Module Arrangement (IN-TBMA) was signed with IO during Feb-2015. India is committed to deliver its



*Figure A.2.4.1 Radar Level Sensor showing horn antenna (left) Ultrasonic wave based liquid metal flow meter Valve integrated with Cryopump (top)*

*The ITER is a unique opportunity to test the tritium breeding blanket module concepts that would lead in a future DEMO fusion reactor to tritium self-sufficiency, the extraction of high grade heat and electricity production. India has planned to test the Lead-Lithium cooled Ceramic Breeder (LLCB) through its Test Blanket Module (TBM).*

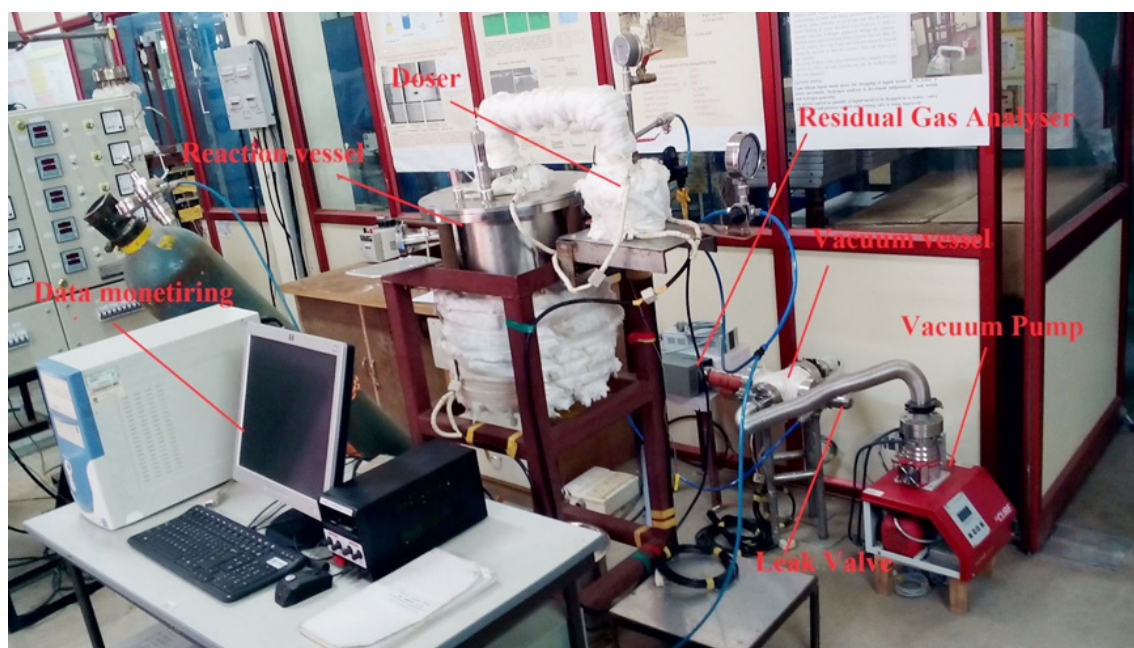

Figure A.2.4.2  
Lead-Lithium-  
water safety  
experiment set up

TBM systems as per the schedule in line with ITER assembly schedule. Presently preparation for conceptual design for LLCB TBMS-Set, First Wall Helium Cooling system (FWHCS), Lead-Lithium Helium cooling system (LLHCS), Lead-Lithium Cooling Systems (LLCS), Coolant Purification System (CPS) and Tritium Extraction Systems (TES) are under final stage. The submission of CDR documents will take place during April-May 2015. Neutronic design for LLCB TBM-Set has been completed and following this, the engineering design of LLCB TBM including thermal analysis, thermo-fluid MHD analysis, Electromagnetic analysis and structural analysis has been completed. The preliminary design of FWHCS, LLHCS, LLCS, CPS and TES has been completed and their documentation is under progress. Nuclear performance evaluation plays an important role in design and nuclear radiation regulatory licensing of Indian Test blanket Module System (TBS) in ITER. These analyses have been carried out to support the LLCB TBS engineering design, nuclear safety assessment, Rad-Waste classification & management. The Neutronic Analysis Report (NAR) contains nuclear performance Analysis of IN LLCB TBS, the data generated is utilized in engineering design and analysis, safety assessment, rad-waste assessment and other supporting analysis of LLCB TBS. This document has been prepared for the Conceptual Design Review of LLCB TBS in ITER.

**Lead-Lithium technologies development:** Lead Lithium Cooling System (LLCS) is one of the major systems of Lead Lithium Ceramic Breeder (LLCB) Test Blanket System (TBS). Various off-the-shelf equipment/components are being devel-

oped or suitably modified from on-the-shelf items and being tested for their operability, reliability, accuracy and lifetime in lab scale small to large experimental set-ups. The operation of LLCS relies on accurate measurement of system process parameters for high temperature liquid metal. Diagnostics, which do not come in contact with hot and corrosive liquid metal and hence do not make local disturbance in the flow parameters (non-intrusive), are attractive due to stringent operational environment. Radar sensors (see figure A.2.4.1), a

*Many small experiments have been set up to study and optimize the various processes which would be utilized in designing the TBM.*

non-intrusive method for continuous level measurement has been successfully tested in liquid Lead up-to 300°C. Another non-intrusive technique of using ultrasonic waves for high temperature (> 200 °C) liquid metal flow measurement is underway (see figure A.2.4.1).

Other components such as custom made cartridge heater, pneumatic actuator based high temperature liquid metal valves are also being tested for their performance in molten Pb-Li environment. In order to gain operational experience on high temperature liquid metal loop operation, a liquid metal heat transfer (Lead to Lead Lithium) loop was operated continuously 24 hrs a day for about 90 days in three phases.



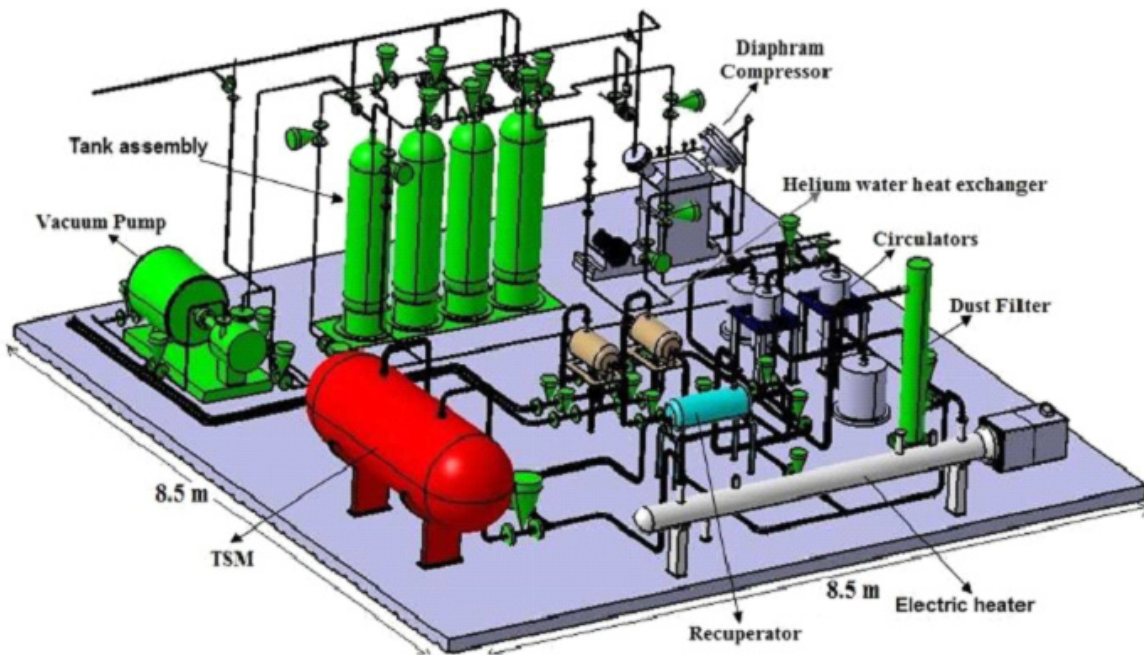

*Figure A.2.4.3  
 Preliminary  
 lay-out of  
 Experimental  
 Helium Cooling  
 Loop (EHCL)*

A small scale lead lithium production system has been fabricated and testing of lithium injector has been successfully completed. The production of Pb-Li alloy will start very soon after the preliminary testing of the integrated system. The corrosion loop for IN-RAFMS corrosion studies in Lead-Lithium is in operation. The loop temperature is 450-500°C, the INRAFMS samples are loaded in the test section and planned to operate up to 10,000 hours. At regular intervals the samples will be removed for analysis.

*Lead Reactivity Experiments:* The Lead-Lithium –water reactivity is of high importance for LLCB TBS safety analysis. As there is no database available for the actual accidental scenarios, there is a requirement to perform lab experiments to study the reactivity and generate wide database to support the safety analysis report for LLCB TBS. In this connection, a Lead-Lithium reaction with water safety experiment has been designed and being operated for database generation.

*Experimental Helium Cooling Loop:* Experimental helium cooling systems (EHCL) development in IPR is under progress (Figure A.2.4.3). The preliminary design of EHCL has been completed. For the EHCL design, ASME Boiler and Pressure Vessel codes are the main reference code used for design, fabrication, examination, inspection, testing, and certification. SS316L is chosen as the structural material for the loop equipment and pipes. Instrumentation & Control (I&C) system of EHCL is being prepared for maintaining the safe

performance of the system at all working regimes & to carry out a number of experiments. The assembly and integration is expected in a short period. The operational experience in the EHCL will be one of the main R&D objectives.

### A.2.5 Large Cryogenic Plants & Cryo-systems

After the conceptual design of the Helium refrigerator/liquefier (HRL) plant, works towards detailed design of prototype components and cryogenic test facility for these, specification generations for procurement of equipments to establish test facility etc are being done. Planning, design and analysis have been done to reduce the cost of the project and use more indigenous technologies; specifications have been generated, such that, many of the costly equipments meant for test facility can be used for indigenous helium plant also. For review

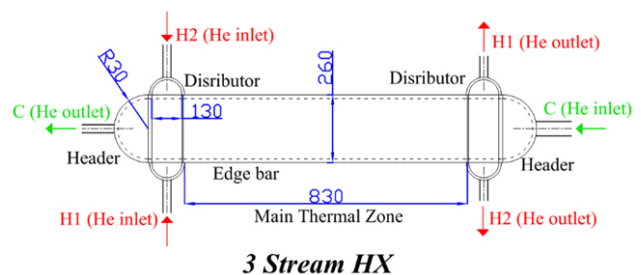

**3 Stream HX**  
*Figure A.2.5.1 Overall dimension (mm) of Prototype  
 3-stream heat exchanger*

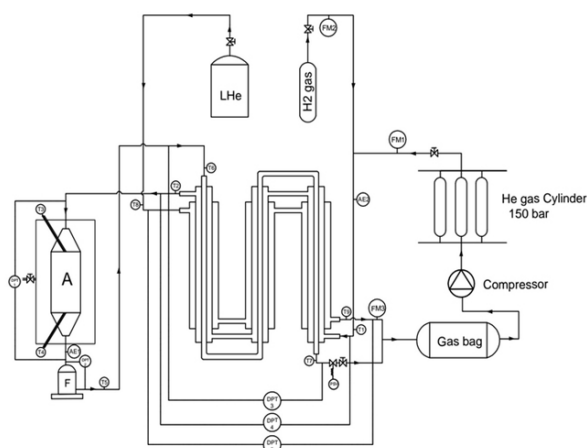

Figure A.2.5.2 Test set-up for prototype helium purifier

**The future fusion based power stations are expected to have very large superconducting magnets which would require very large cryogenic plants. This activity plans to build large cryogenic systems through small modular cryogenic plants**

of project plans and design concepts, a steering committee having national experts have been formed in June-2014 and 2 meetings have been conducted in the year 2014-15. Looking at the different prevailing situations, the first target capacity of indigenously built HRL plant is fixed for 1 kW refrigeration at 4.5 K. Few critical components like, helium compressor with oil removal system, helium turbo-expanders and cryogenic valves will be purchased from abroad for initial runs to validate other components and HRL plant engineering. Later these will be replaced by indigenously developed ones.

*Analysis of thermodynamic cycle of HRL:* The modified Claude cycle, having 3-turbines (2 warmer turbines are hydraulically connected in series and the colder one is hydraulically in series with Joule-Thomson (JT) valve) and 8 heat exchangers, will be used in the indigenous helium plant for production of liquid helium. To have 1 kW refrigeration at 4.5 K, the helium flow rate and compressor discharge pressure, are necessary parameters for optimization (minimization) as these will decide the electrical power consumption

and in turn the running expenditure. To reduce the running expenditure, design should not end up with high capital cost. This optimization and analysis involves the turbine inlet and outlet conditions, eight heat exchangers' inlet and outlet conditions, 2 purifier beds' inlet and outlet conditions. This optimization work also gives the process parameters for different cold components involved in the main thermodynamic cycle of the HRL plant. These process parameters decide the overall capacity/specifications of different main components and sub-systems of the plant

*Design of prototype plate-fin heat exchanger:* Here, in this indigenous HRL plant, there will be 8 different plate-fin heat exchangers. All these can be grouped into 3 types: 2-stream-He/He, 2-stream-LN<sub>2</sub>/He, 3-stream He/He/He type. Heat exchanger effectiveness, required is up to ~96% which can be met by only plate-fin heat exchangers (PFHE) and with counter-flow configuration. Besides complex geometry, design and optimization procedures, there are practical problems like flow mal-distribution, axial conduction, inter-stream leakage and limitation of size of vacuum brazing furnace. Looking at these aspects, amongst different type of fins, serrated fin has been chosen for all 8 plate-fin heat exchangers. The prototype of these heat exchangers will be made indigenously and these have been designed. Here, figure A.2.5.2, gives the overview of the prototype 3-stream plate-fin heat exchanger dimensions and flow arrangements. Two hot streams (h1 & h2) of two different pressures (14 bar and 6 bar) will be cooled by one cold stream (C1) of pressure 1 bar. The flow rate of cold stream is ~38 g/s and overall dimensions are as shown in Figure A.2.5.2. The dimensions have been chosen looking at the available brazing vacuum furnace in the Indian industries. Similarly the fin specifications have been decided based on Indian industries' capability.

*Prototype purifier design:* In the whole helium plant, there are 3 stages of helium gas purifications, which use adsorption principle for impurity removal: oil impurity removal in the oil removal system of CORS at room temperature ~300 K, air impurity (N<sub>2</sub>, O<sub>2</sub> and Ar) removal at temperature ~80 K inside the cold box and hydrogen impurity removal at temperature ~20 K inside the cold box of the plant. The expected amount of impure gas in the helium stream for 20 K and 80 K could be about 10 to 100 PPM (parts per million by volume) and for 300 K purifier, this is expected to be between 1 to 10 PPM. These impurities if not removed from the helium stream can damage the turbines when these will hit as frozen particle or small liquid droplets. It can also choke the fluid passages

as at low temperature down to 4.5 K, these gases will freeze. The open literatures and journals for these purifiers are very few and not sufficient for right design. Hence, to generate the design data (mainly mass transfer zone (MTZ) and adsorption capacity characteristics), prototype purifier for smaller helium flow rate (about 1 to 2 g/s) is designed and will be tested at temperature 20 K. For helium circulation, helium recovery compressor will be used along with pressure regulators to reduce the helium pressure to about 14 bar. 3-stream heat exchanger (tube-in-tube) is designed to reach to 20 K by using return cold helium from adsorber bed and LHe. This set up can also be used for adsorber bed test at temperature 80 K using LN<sub>2</sub>. This test set-up will also include micro-mesh filters, developed with the help of local industry. Data Acquisition and control system for this is being developed at IPR. It will involve measurement of temperature, pressure and pressure drops and impurity contents with time.

*Prototyping and testing:* A new type of electrical isolator for LN<sub>2</sub> and LHe transfer lines have been developed at by LCPC and NBI team of IPR and these can sustain high thermal shock of about 1000 K/hr and can provide high reliability for leaktightness of about 10<sup>-8</sup> mbar.ltr/s. Cryogenic electrical isolators have been difficult to make such thermal shock resistant due to involvement of metal and composite insulating material. Such high thermal shocks are, often, faced in the cryogenic operations leading to cracks and leaks and normally to avoid such problems very controlled cooldown is done. With these electrical isolators, the worry of cooldown-induced problem can be removed completely.

## A.2.6 Remote Handling & Robotics Technology

Remote handling is often described as the synergistic combination of technology and engineering management systems to enable operators to safely, reliably and repeatedly perform manipulation of items without being in personal contact with those items. The scope of the project is to build a versatile Remote Handling System for Indian fusion devices. The development of the technologies and systems will be in a parallel and interrelated mode with support of external agencies and institutions. As a part of XII Plan, setting up of the Virtual reality facility at IPR and development of the SST-1 viewing & inspection system are the main deliverables of the RHRTD Division. The division has kicked-off the SST-1 viewing & inspection system. The specifications of the VR facility have been finalized and the system will be setup in the coming year.

*Virtual Reality (VR) Facility Development:* Remote operations require an accurate perception of a dynamic environment. The aim is to give the operators the same unrestricted knowledge of the task scene as would be available if they

*Remote Handling and Robotics technology would be a vital technology for the maintenance of plasma facing components and other sub-systems of a fusion machine. Here it is being developed through international collaborations.*

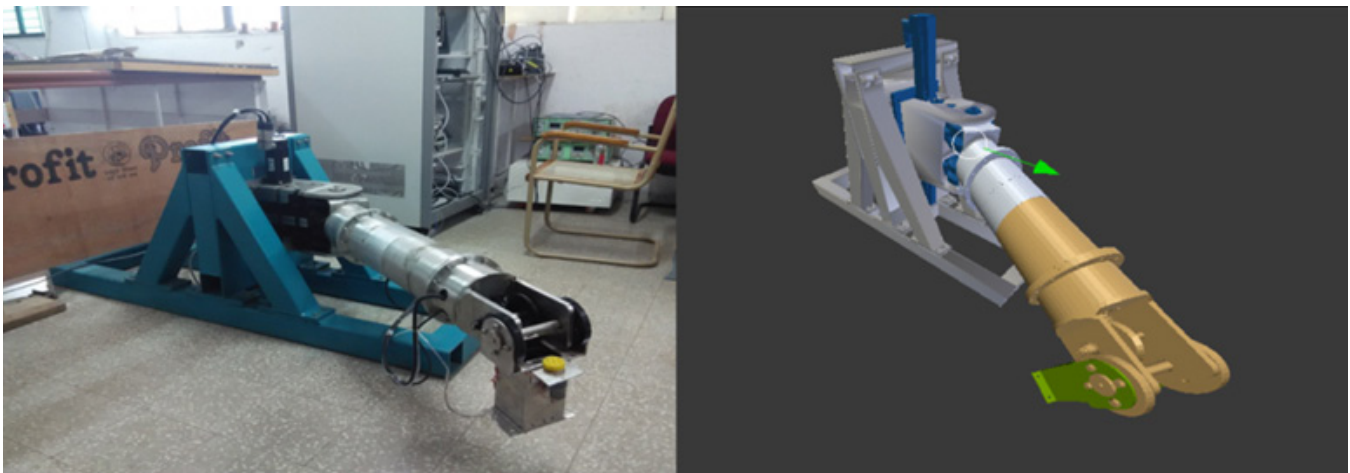

Figure A.2.6.1 Prototype Robotic Articulated System for 5kg payload and 1.5 m length



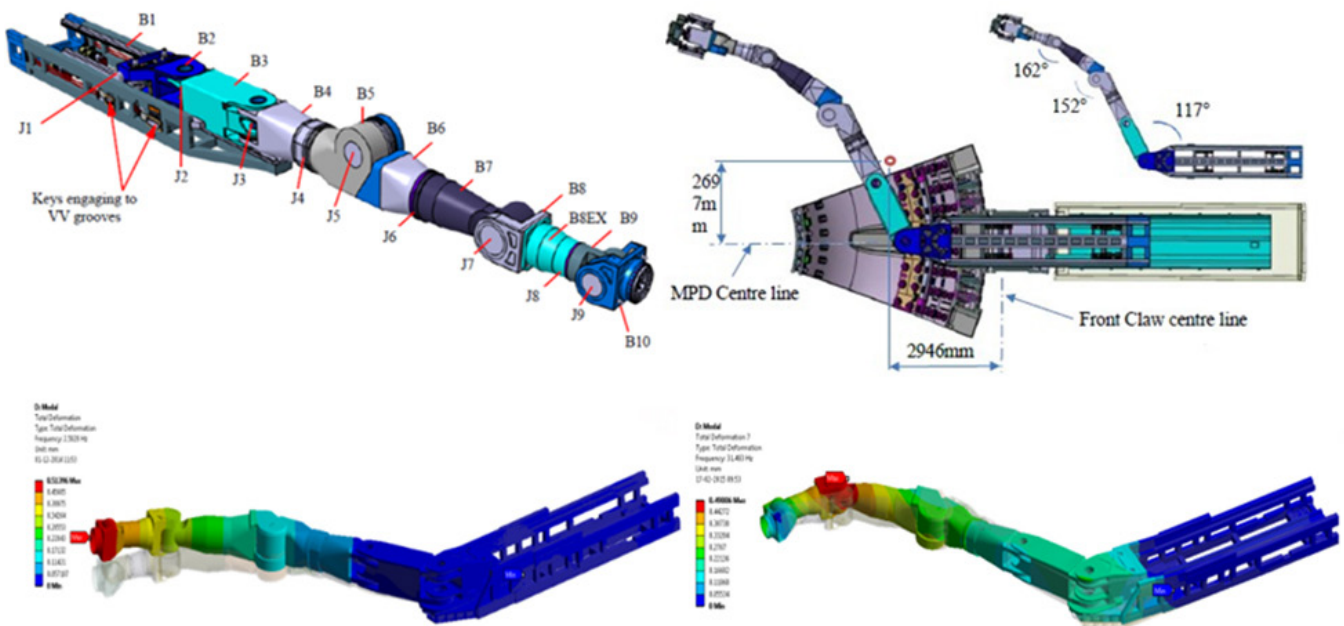

Figure A.2.6.2 the ITER Multi-Purpose Deployer (MPD) for ITER Remote Handling System

were located in the remote environment. In fact, the Virtual Reality (VR) system can give an overview over the entire scene which is better than being present at the workplace. In addition, different algorithms will be integrated with the VR system like collision avoidance algorithms, path planning algorithms etc. To study the kinematics of large scale robotic systems, operator training, operation sequencing studies and 1:1 scale virtual mock-up, a Virtual Reality Facility is being established. This system will be integrated to actual robotic systems for monitoring and control of robotic operations. The fully immersive VR system is planned to have dual high resolution screens integrated with 6D tracking device and a large number of haptic devices including a 6 DOF force feedback master arm. A Virtual and Augmented Reality Integrated Development (VARID) Lab is also being planned. This setup will be used to research and development of applications for VR and AR that will be integrated to real time RH systems.

*Assembly And Testing Of Prototype Robotic Articulated System (PRAS 01)* - A Prototype Robotic Articulated System (PRAS) has been developed having 5 Kg payload capacity and 1.5 meter in length that composed of three degree of freedom. The system has been successfully tested at the RHRTD lab with PXI based real time control systems (LabVIEW RT). The system is also integrated to a virtual model, created in blender, which is updated at 10Hz in real time.

Conceptual Design Of Prototype Robotic Articulated System (Pras 02): With the successful design and development of the PRAS-1, the RHRTD team is presently developing PRAS-2. This system is a 5 DOF equipment exhibiting snake like articulation for traversing a toroidal workspace. The system is designed to carry a maximum payload of 20kg at 2m. The system will be integrated to haptic controlled virtual reality setup for online control, tracking and monitoring of operations.

#### International Collaborations

Collaborations and Task agreements are being run with ITER on validation of the ITER RH Control system, Concept design and system analysis of the Multi-Purpose Deployer, Remote handling compatibility assessment of the ITER MPD and ITER Diagnostic systems. The following are some of the major contributions.

Engineering support to ITER RH Control Systems - The integrated prototype work-cell has been implemented in this task. The prototype work cell consisted of a total of 04 RH control sub-systems – RH equipment controller prototype, RH Viewing system prototype, Virtual reality monitoring prototype and RH plant controller prototype. The implementation was carried out so as to validate the RH Core System platform for



RH control system applications. All the 9 deliverables have been successfully completed and delivered to ITER RH Section.

Concept design and system analysis of the ITER Multi-Purpose Deployer (MPD) - The Multi-Purpose Deployer (MPD) is a general purpose ITER in-vessel remote handling (RH) system. The MPD will perform various in-vessel maintenance tasks such as dust and tritium inventory control, in-service inspection, leak localization and in-vessel diagnostics maintenance. The MPD Transporter consists of a series of linked bodies; B1 to B10 Articulated Transporter, is able to travel along the Mounting Equipment. The MPD is a multi-body system, so it has infinite number of configurations. The critical loading configuration is when MPD is deployed in the VV with fully extended configuration. This paper presents the seismic structural analysis results of the concept design of the MPD Transporter. Static structural, modal and frequency response spectrum analyses have been performed to verify the structural integrity of the MPD itself, and to provide reaction loads to the interfacing systems such as vacuum vessel and cask.

Amendment to the Remote Handling Control Systems Task Agreement: The objective of this work is to carry-out the detailing of the RH maintenance tasks, construct simulation task environments, demonstration of the RH tasks and performance assessment for the following tasks: (i) Decontamination of RH equipment in Hot Cell; (ii) Blanket manifold removal/installation and (iii) Maintenance of RH equipment in Hot Cell.

Remote Handling Compatibility Assessment of the Diagnostics Systems - The major scope of work of this task is to support the ITER diagnostics division in its execution of the work on Remote Handling Compatibility Assessment of the Diagnostics Systems in support of Design Review activities. As a part of the task agreement with ITER-IO, the Remote Handling Compatibility Assessment (RHCA) for ITER Diagnostics systems like Hard X-Ray Monitor System (HXRM), Neutron Flux Monitor System (NFMS), Lower and upper vertical neutron cameras (VNC) were carried out at IPR.

## A2.7 Negative Ion Neutral Beam System

The activities under this project comprises of the following: (1) Negative ion source development: (a) ROBIN, (b) TWIN source (2) Indian Test Facility (INTF) activities. The brief about these activities are given below.

*Positive ion based NBI has been available for quite some time. But the negative ion based NBI is still in the very early stages of development. Since India has also joined in the technology development through international collaborations, it will benefit the domestic programme enormously.*

### ROBIN

Realisation of integrated beam operation of ROBIN in volume mode with two HV power supplies (EPSS & APSS) has been the highlights of NNB experiments. In that line of action, the major activities in ROBIN setup can be divided into three sections: (A) Power supply, (B) Data Acquisition and Control System (DACS); (C) ROBIN Ion source and Caesium experiments.

(A) Power supply activities in last one year comprises of (a) Factory acceptance test (FAT) of 35kV, 15A DC Acceleration Power Supply System, (b) Installation and commissioning of Resistive load bank of capacity 550kW along with heat exchanger for the load testing of 11kV, 35A DC, Extraction Power Supply System (EPSS) and APSS and (c) Site acceptance test (SAT) of APSS, after its installation and commissioning at IPR (see figure A.2.7.1). Later EPSS and APSS are hooked up together with ROBIN source, as per negative ion beam extraction and acceleration configuration and the cor-



Figure A.2.7.1 Power Supplies installed for Negative Ion Beam Source Experiments



*Figure A.2.7.2 Control panel for Power Supplies*

responding total voltage measured was -46kV w.r.t ground during that operation. During FAT, along with standard the tests, following critical tests were performed (in both local and remote mode): (i) Wire test to ensure energy dump during breakdown does not exceed 10J near load end, (ii) repeated Breakdown test for 200 Nos., (iii) Heat run test at full rated power for 3600sec and (iv) HV Isolation test up to -70kV DC. During SAT, both EPSS and APSS are operated successfully to their independent full ratings, integrated with NNBI (DACS), in No-load and Full load conditions.

(B) Data Acquisition of ROBIN is upgraded to accommodate APSS and EPSS operation through remotely. Integrated operation of APSS and EPSS in actual configuration is tested with dummy load in full specification through the ROBIN DACS during SAT and commissioning phases. All the interlock and safety functions have been incorporated in DACS and tested successfully.

(C) ROBIN ion source and Caesium experiment activities in the last one year consists of systematic 20kV beam operation for different pressure and power level with already installed EPSS and 10kV, 400mA HVPS together with negative ion density measurement with Laser photodetachment diagnostic, making arrangement of Doppler Shift Spectroscopy (DSS) for negative ion beam and Cs oven fabrication with 3m long delivery tube. In Cs experiment, to remove the moisture from the system, Ar gas flushing into the system at elevated temperature was successfully implemented which was confirmed by RGA measurements at the Cs reservoir location. The system showed better performances in terms of control over Cs flow in better vacuum conditions. The Cs oven was

tested in a temperature range of 150 – 220°C. A Cs flow rate of ~35 mg/hr. (relevant to DNB source) was achieved. To have better control over Cs flow a metallic shutter was introduced near the nozzle of Cs delivery tube. Microbalance were introduced as an additional Cs diagnostics to remove the uncertainties in SID measurements and other issues like recycling of the Cs vapor in the vacuum vessel.

### *TWIN Source*

TWIN source (TS) experimental activities in last one year can be divided into mainly (A) manufacturing of mechanical systems and (B) acceptance tests of different electrical systems. The vacuum vessel to house TS is manufactured, delivered and commissioned in TS lab area. The TWIN source manufacturing contract is signed with an Indian Company, M/S Hind High Vac (HHV), Bangalore and manufacturing procedures are being established. Vacuum pumping system (TMP with Rotary backing) has just arrived in the lab. Acceptance tests of 150kVA, 3-phase, 415V/415V transformer of isolation 100kV DC between primary and secondary has been successfully done both at manufacture's site and IPR. Some critical tests that are performed on the transformer are: (a) isolation test between secondary and primary up to 100kV DC, (B) Isolation test between secondary and secondary shield up to 100kV DC, (c) Temperature rise test, (d) Double voltage double frequency test, (e) Magnetic balance test and (f) Vector group test. Testing of filament heating and bias power supply system integrated with TS DACS and has been successfully completed in both local and remote mode. 100kV isolation platform which will house (a) 2nos. of 128V, 2A DC Filament Heating power supply, (b) 16V, 10A DC Filament Bias power supply and (c) 60V.

### *INTF activities*

Indian Test Facility (INTF) vacuum vessel (Diameter 4.4m, Length 9m) is under manufacturing. (as shown in figure A.2.7.3). Midterm, stage-wise inspections are being carried out regularly. At the time of preparation of this report, the FAT of the vessel has been concluded and all specifications have been met. The commissioning of it is expected soon. INTF HV feed-through, which provides 100kV isolation between Vessel and HV Transmission line is designed considering porcelain ring as main insulator assembly). 120kV HV DC isolation test on a relatively small (diameter ~ 450mm, length ~620mm ) porcelain ring (provided by BHEL, Banga-



*Figure A.2.7.3 Manufacturing of Indian Test Facility Vacuum Vessel*

lore) has been carried out successfully. In parallel  $\text{Al}_2\text{O}_3$  ceramic based proto-type HV bushing as per ITER HV bushing design concept is manufactured and assembled to quantify the electrical stress. Ceramic is procured from Japanese company (Kryocera) and remaining parts including stress-shield, FRP ring are manufactured in India.

INTF Data Acquisition and Control System (DACS) is designed based on ITER Plant Control Design Handbook (PCDH) guidelines. The INTF DACS is responsible for ensuring smooth operations and acquire signals for entire duration of 3600 sec. The total number of control and acquisition signals is around 900. Slow control and DAQ system is based on Siemens S7 plc and fast control and DAQ system is on NI PXIe hardware platform. The software platforms CODAC Core System will be used for slow control and providing main Human Machine Interface (HMI); and Labview will be used for fast control and data acquisition. Factory and Site acceptance testing of conventional control and data acquisition system hardware has been completed successfully. Development of prototype for INTF DACS, based on CODAC Core System is tested during TS RFG SAT and later it will also be tested with Twin source experiment to gain experience before INTF operation. Further INTF DACS specific prototyping activities are being undertaken in areas of long pulse 3600 sec monitoring and event based acquisition.

INTF Diagnostics is divided into three categories: (a) Protection diagnostics with active interlocks for safe operation, (b) Monitoring diagnostics to monitor the health of the system and (c) Characterization diagnostics for characterization of

the plasma and the beam. Categories (a) and (b) diagnostics are the integral part of the BLC designs, as these comprises of thermocouples, vacuum gauges, electrical sensors etc. with emphasis on the category of characterization diagnostics. FLIR make Infra-red camera has been procured and its SAT has been performed, Mirrors for Cavity Ring Down Spectroscopy (CRDS) along with the Nd-YAG laser, vibration-less optical table and the detectors are also available in the lab and CRDS table- top experimental setup is being erected.

### **A.2.8 Fusion Reactor Materials Development & Characterization**

*Materials Development* : The scope of the ODS steel development project is to develop and produce ODS-9Cr RAFM and ODS-14Cr RAF steel powders and to process these powders by hot isostatic pressing and subsequent hot forming operations like hot rolling to plates, for fusion reactor applications. ODS steel plate has been made using RAFM steel powder produced by Gas Atomiser and further processing such as mixing of powder with Yittria at ARCI and HIPing and Hot rolling at DMRL, Hyderabad. The characterization of the ODS steel plate has been done for the mechanical properties. The activities for functional materials for fusion reactors such as  $\text{MgAl}_2\text{O}_4$  ceramic development activity for IR and RF windows, is in progress with the trials of synthesis using solid state route. A part of proton conducting ceramics

***Though the fuel is not radioactive (both before and after burn), efforts are on to achieve zero radioactivity in all other materials to be used in the fusion power plant. This includes selection of material composition and their structure. This activity is to orient the material studies in that direction.***

preparation and characterization will be done in collaboration with the faculty members from Pondicherry University and RG CET, Puducherry, for which a project proposal has been approved by Plasma and Fusion Research committee, BRNS. Tritium permeation barrier coating ( $\text{Er}_2\text{O}_3$ ) development activity has been progressed with the improvement in the film structure using reactive sputtering and dip coating techniques. Spectroscopic Ellipsometry measurements on reactive sputter coated erbia samples were completed. Analysis



of AFM data measured on reactive sputter coated erbia samples is pursued and it shows that roughness of the sample has a maxima as a function of processing temperature. Systematic DC resistivity measurements on erbia films is carried out on reactive sputter coated films processed at different temperatures and parameters.

**Materials Fabrication R & D:** The defect size calibration and detection technique using known size weld defects with DAC generation in weld samples (Distance amplitude curve fitting) has been established as a part of NDT activity. Ultrasonic scan tests were conducted by angle probes of different calibration using B-scan and TOFD probes for 20 mm thick and 60mm thick TIG welds, establishing the weld defects analysis procedure and correlation with radiography tests. EM pulse welding and analysis has been done for applying this technique to ODS steel plate joining activity, planned in future. The tensile and shear fractured Cu-SS laser cladded samples have been analyzed with SEM and EDS techniques. Tensile testing of 10 mm thick EBW SS316L samples, prepared under different heat input conditions, has also been carried out.

**Materials Irradiation and characterization:** For the IAEA-CRP (coordinated Research Project) entitled 'Radiation damage and H/D retention studies on ion-irradiated Tungsten and its alloys - Experiments and Modeling', work has been carried out using Accelerators at IUAC, Delhi, for heavy ions (Au and W) irradiation in Tungsten. The irradiated samples have been characterized at IPR and BARC for Structural, Microstructural and morphological characterization using XRD, GXRD, SEM, AFM and PAS. The structural and Microstructural changes such as preferred orientations, stress development and defect formation observed after irradiation in Tungsten has been analyzed. The modeling work is also in progress. Further experimental work at IPR, IUAC and IG-CAR is being planned.

## A.2.9 Fusion Fuel-Cycle Development

**Development of laboratory scale hydrogen isotopes removal system (HIRS) for He purge gas:** This system would be used to validate design concepts for tritium extraction. The complete HIRS consists of Atmospheric Molecular Sieve Bed (AMSB) column (for removal of moisture from He purge gas), and Cryogenic Molecular Sieve Bed (CMSB) column (for removing hydrogen isotopes and impurities) as main subsystems. Different components of AMSB have been in-



**Figure A.2.9.1 Atmospheric Molecular Sieve Bed system under operation**

tegrated and experiments are initiated. It is observed that for percentage level of moisture in He feed gas, this system works. However, for our ITER relevant experiments, the moisture level should be in ppm level. So, a humidification

*In fusion, the isotopes of hydrogen viz. deuterium and tritium will be used. Here tritium is a radioactive element with approximately 12.5 years of half-life. Hence tritium is not naturally available and needs to be produced from lithium. In this activity the fuel cycle of both isotopes will be developed.*

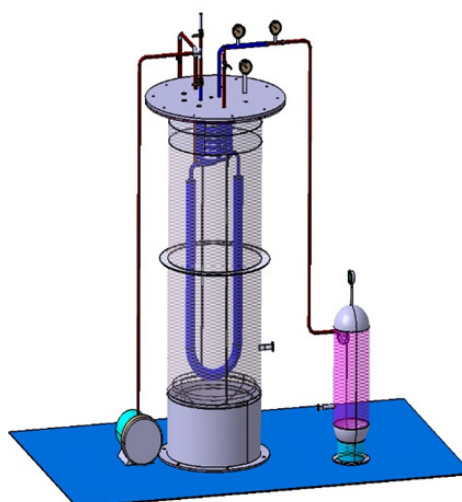

**Figure A.2.9.2 Layout of designed Cryostat and Cryogenic Molecular Sieve Bed System**



**Figure A.2.9.3 Installed setup for hydrogen isotope permeation study**

system for introducing ppm level of moisture in He gas is being developed. Preliminary experiments with the humidification system are initiated. Design of the cryostat and CMSB has been completed and layout of the same is shown in Figure A.2.9.2. Once the analysis is over, CMSB will be fabricated.

*Experimental results of separation of impurities and hydrogen isotopes in He gas using Gas Chromatograph (GC):* A couple of experiments have been performed using GC. First experiment involved analysis of impurities in He gas at 303 K and the second one involved analysis of hydrogen isotopes in He gas at 77 K. The separation of impurities  $H_2$ ,  $O_2$  and  $N_2$  (10 ppm each) from He gas is demonstrated at 303 K using packed column (Zeolite 13X) and the retention time is less than 2 minutes. In the second experiment separation of  $H_2$  and  $D_2$  (10 ppm each) from He gas is observed at 77 K using packed column (Modified Alumina) with retention time less than 3 minutes. Both these results are very encouraging and can be used for separating these species from He gas.

*Development of Hydrogen Isotope Extraction System (HIES) for liquid PbLi:* Fabrication drawing for the packing column has been prepared and fabrication would start soon. Procurement of the off the shelf components are under progress.

*Development of experimental set up for determining solubility of hydrogen isotope in liquid PbLi:* Fabrication of solubility chamber has been initiated. Procurement process for the off the shelf items (viz., vacuum pump, mass flow controllers, electronic pressure controllers, capacitance manometers, residual gas analyser, temperature sensors, temperature controller, etc.) are under progress.

*Hydrogen isotope permeation study to qualify TPB coating:* Installation and commissioning of the experimental setup is complete. Preliminary experiments are under progress. A picture of the installed setup is shown in figure A.2.9.3

--!!!--

### A.3. Basic Experiments

The institute has a very strong experimental program on fundamental plasma sciences. This exciting programme caters mostly to the requirements of Ph.D. student programme. The current programme has experiments under the following heads:

A.3.1 Large Volume Plasma Device (LVPD) Experiment	28
A.3.2 Basic Experiments in Toroidal Assembly(BETA)	30
A.3.3 Interaction of Low Energy Ion & Neutral Beams with Surfaces	30
A.3.4 System for Microwave Plasma Experiments (SYMPLE)	30
A.3.5 Plasma Wake-Field Acceleration Experiment (PWFA)	31
A.3.6 Magnetized Linear Plasma Device	31
A.3.7 Experiments on Dusty Plasmas	31
A.3.8 A Linear Helicon Plasma Device With Controllable Magnetic Field Gradient	33
A.3.9 Non-Linear Dynamics In Dc Glow Discharge Plasma	33
A.3.10 Multi-cusp Plasma Experiment	33
A.3.11 Non-Neutral Plasma Experiment (SMARTEX-C)	34
A.3.12 Plasma Torch Activities	34

#### A.3.1 Large Volume Plasma Device (LVPD)

Physics experiments are being continued in Electron Temperature Gradient (ETG) turbulence studies and relevant plasma transport. Now the studies has also been expanded towards understanding non-linear properties of ETG turbulence. We have made successful attempts in explaining the physics of Electron Energy Filter (EEF) but most noticeably succeeded in explaining the nature of turbulence in the source plasma of LVPD. Plasma Transport in the background of Electron Temperature Gradient Driven Turbulence in Target Plasma: Initial investigations are carried out towards fluctuation induced plasma transport in the background of ETG in target plasma of LVPD. We have observed that in the presence of ETG, the fluctuation induced particle transport enhances significantly w. r. t. the particle transport in absence of ETG. Beside this, investigations are also undertaken for mode conversion/coupling process for core and edge turbulence. We have characterized LVPD plasma for higher ambient magnetic field. This is being done to raise the electron and ion gyro frequencies much above the conventional frequencies excited by power supplies used for plasma production.

*Turbulence in the near EEF region:* The turbulence in near

*Basic experiments help in understanding the various properties of plasma state in both of naturally occurring and man-made ones. Apart from helping to develop various based technologies, they also help in developing the human resources for future endeavours*

EEF region assumes significance because of the complicated magnetic field profiles prevailing in the region. The EEF produces a strong transverse magnetic field of 160G against the axial magnetic field of 6.2G. The physics of EEF can be understood in the following perspective. The EEF stops the energetic electrons from passing across EEF to target region and restricts them in the source plasma region itself. The physical analogy suggests that the energetic electrons suffers very few collisions within EEF and gets swept away all along the axis of EEF to the wall of LVPD. However, to our surprise, no traces of these electrons are observed in the outer circumference of EEF. Our investigations in the near EEF



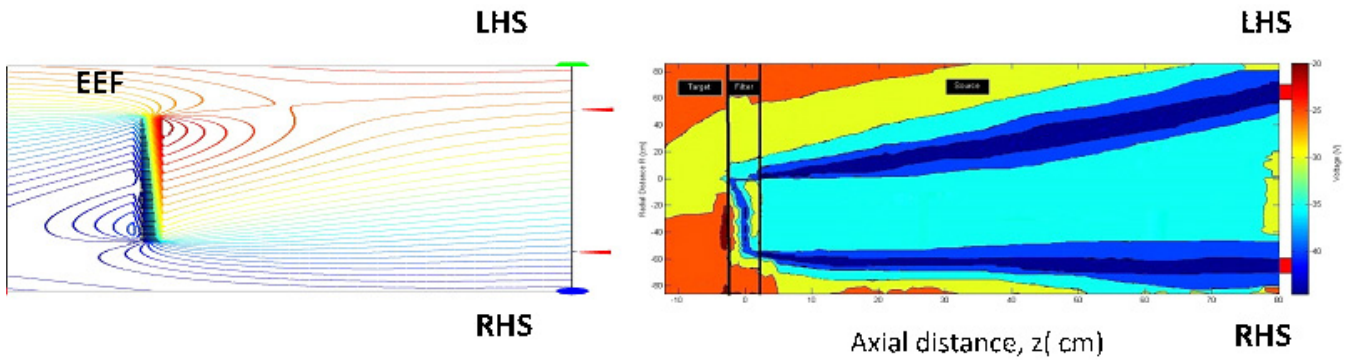

**Figure A.3.1.1** Correlation of peak floating potential profile in source, Electron Energy Filter and Target region with the simulated field pattern of coupled magnetic field and ambient magnetic field of LVPD

region on plasma turbulence led us to the identification of instability as Rayleigh Taylor (RT) instability. The question of identifying loss path of energetic electrons is still a mystery although some indications of their loss through excited instability in the energetic belt region of source plasma are recently observed.

*Turbulence in the Source region:* The distribution of peak floating potential over the x-z plane in the experimental region of source, EEF and target plasmas is shown in figure A.3.1.1. The contour plot is generated from the radial profiles of peak floating potential taken by an axial array of Langmuir probes (No. of probes 32, diameter: 1mm, length: 10mm) mounted on a radially movable probe shaft. The probes are separated axially in a step of 2.5 cm. It shows a direct correlation between the energetic electrons distribution in the source

region and the magnetic field pattern. Many features observed in the experiment suggest that the observed turbulence has relevance to whistlers, excited in near earth atmosphere and the whistler instability excited in the Van Allen belts of earth magnetosphere.

*System up gradation and Diagnostics development:* During last year, major system up gradation activity is undertaken in LVPD towards integration of various subsystems. We have provided a LabView interface to 10kA/20V power supply. This interface allows control of the shape of cathode heating profile and emission profile of the new source. We have developed another important component named as flexible high current feed through, needed to provide a coupling of power to plasma source from the newly developed high current power supply[ see figure A.3.1.2]. During this year, all 12 radial ports are upgraded with computer controlled Lab



**Figure A.3.1.2** Developed high current flexible length feed through. This has an absorption length  $> 1.2\text{m}$

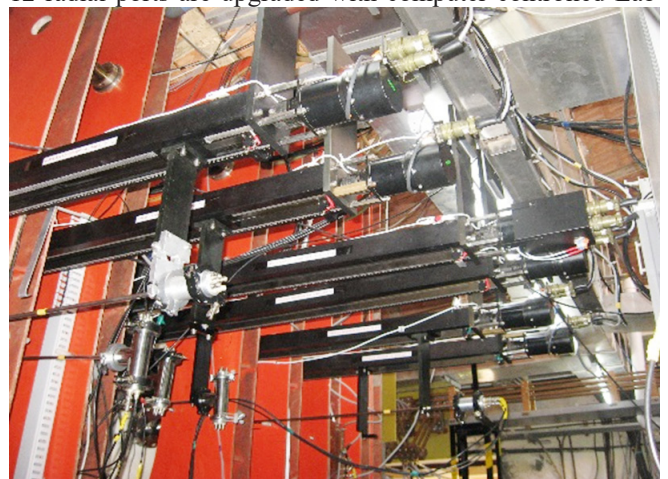

**Figure A.3.1.3** A few large, linear motion, vacuum interfaced probe drives with  $\sim 1\text{ m}$  travel length

View interfaced, linear probe drives for diagnostics movement [see figure A.3.1.3]. In the data acquisition front, a major development has taken place in the form of release of order for the purchase of 40 channels; PXI based Data Acquisition System (DAS).

### A.3.2 Basic Experiments In Toroidal Assembly (Beta)

A systematic experimental campaign was carried to first reproduce earlier experiments on fluctuation driven flow in the absence of vertical coil current. In the process, it was found that the Mach probe results were inconsistent. A series of new Mach probe designs were attempted and issues were identified and rectified. Current Mach probe produces consistent results. It can be expected that due to small errors in B<sub>T</sub> coil alignments, toroidal field lines do not close on themselves. In order to be able to determine the topology of field lines, a simple, yet very effective field line tracing experiment was successfully completed. The experiment was to produce a tiny plasma on a field line using an emissive probe based discharge and allow the plasma to flow along the field line at an appropriate fill pressure of the neutral gas. This method is very inexpensive and very effective in determining the topology of a magnetic field line. This allowed us to determine experimentally, the offset current I<sub>z</sub> in the vertical field coil in order to close the field line on itself. With the achieved accurate control of topology, fluctuation driven flow studies for a range of magnetic field topology has been completed at a given field strength. In parallel, several work corresponding to system maintenance, data analysis were also completed.

### A.3.3 Interaction Of Low Energy Ion & Neutral Beams With Surfaces

Plasma spectroscopy has been carried out in a high density plasma beam produced by pulsed microwaves of 2.45 GHz in an axial magnetic field of 800 Gauss using nitrogen / hydrogen gas mixtures. Emitted spectra (300 nm to 800 nm) were recorded. Starting from pure nitrogen, i.e. zero percentage of hydrogen spectra were taken in steps of 5% increase in hydrogen percentage until it is pure hydrogen, i.e. 100% hydrogen. Our main objective is to find out what is the optimum ratio of nitrogen to hydrogen which produces the maximum intensity of NH and NH<sup>+</sup> which are known to be the main active species responsible for nitriding. The spectra we found are significantly different from those reported for glow discharge plasma and other types of plasma with N<sub>2</sub>/H<sub>2</sub> gas mixtures. We estimated excitation temperature of hydrogen plasma as 0.46 eV. We could also find the presence of NH

and NH<sup>+</sup> species in different combination of N<sub>2</sub>:H<sub>2</sub> mixture ratios. By analyzing the peak intensities due to NH and NH<sup>+</sup> radicals, we concluded that the best N<sub>2</sub>:H<sub>2</sub> ratio should be 65:35.

### A.3.4 System For Microwave Plasma Experiments (Symple)

SYMPLE is aimed at investigation of interaction between plasma and high power microwave (HPM), is taken up in two phases. Phase I involves interaction of moderate (3.1 MW, 3GHz, 5μs) power HPMs, with plasma whereas Phase II deals with HPMs of a few hundreds of Mega Watt power. The developmental works in both the directions are going in parallel, in different laboratories. The Pulse Forming Network (PFN) system used to strike discharges in the washer gun has now been upgraded to deliver shots at a faster rate of one shot in every 20 seconds, compared to the earlier system where the shot-to-shot interval was about 4 minutes. The time sequence of the experiment necessitates the HPM output in single pulse mode. The HPM output characteristic is critically determined by the pulsed modulator driver. The magnetron driver, for our application, needs to generate highly repetitive, single pulses of 52 kV and 120 A with 5μs pulse width and very fast (~ a few hundred ns) rise time. A line type modulator, simple, cost effective, rugged and easy to fabricate, has been designed to deliver pulses of 52 kV, 120 A, 5μs width and ~ 450 ns rise. It consists of a charging power supply, pulse forming network (PFN), a thyatron switch, triggering unit and a pulse transformer. Design of the Guillemin type E type PFN with mutual coupling (15-20 %) between the adjacent sections is verified with PSPICE simulation. Shown in Figure A.3.4.1 are the set-up of this system. A fast voltage rise ~100 nanos and pulse width of 5 micro-sec, as is required for the magnetron, has been achieved. Adding to the existing diagnostics on power measurement from



*Figure A.3.4.1 The Pulsed Modulator System being developed*



the VIRCATOR (Virtual Cathode Oscillator), measurements of the radiated electric field has been carried out using high frequency (up to 10 GHz) E-dot probes. Electric field in the range of 100-150 V/m has been measured, depending on the distance of the probe from the HPM source.

### A.3.5 Plasma Wake-Field Acceleration Experiment (PWFA)

The experiment is to demonstrate an acceleration gradient of  $\sim 25$  MeV/m. The required plasma density for such an acceleration gradient is of the order  $10^{13}$ - $10^{14}$   $\text{cm}^{-3}$  over a length of 1m long homogenous plasma column. The prototype 40 cm long plasma source based on photo-ionized Lithium heat pipe oven (HPO) has been developed and the thermal characterization studies of the HPO have been done. A uniform temperature ( $\sim 775$  °C) of Li vapor column with sharp boundaries on either sides have been obtained at Helium buffer gas pressure of 0.3 mbar and external heater temperature of 900°C. Diagnostic techniques like white light absorption, UV absorption and Hook's method are being used to measure the line integrated Lithium vapor column density. The measurement line integrated Lithium plasma electron density in the heat pipe oven using CO<sub>2</sub> laser interferometry and UV photo-ionization would be carried out. As part of the continuing effort to determine the line integrated Li vapor density accurately using Hook's method, a dispersive - Mach-Zehnder white light interferometer is being setup. As a part of this ongoing project, the LINAC facility is being established. The initial site allotment has been done and site clearance has been obtained from AERB. The preliminary design of LINAC

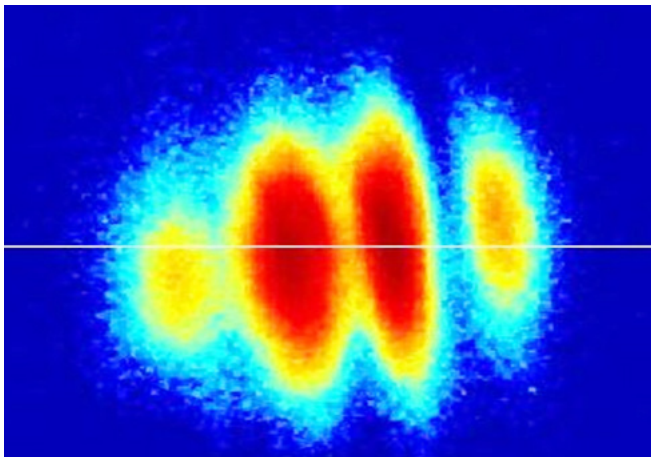

*Figure A.3.5.1 The fringes observed in the CO<sub>2</sub> laser based Michelson interferometry setup for electron density measurement*

building, shielding room and beam line / beam dumps have been finalized taking into radiation and safety calculations (empirical) for Bremsstrahlung radiations and neutron flux. Simulation studies on radiation shielding calculations using Monte-Carlo methods are in progress.

### A.3.6 Magnetized Linear Plasma Device

Inverse Mirror Plasma Experimental Device (IMPED) is a newly commissioned magnetized linear plasma device. Figure A.3.6.1 shows fully assembled device. This device was designed and fabricated in house over the last few years. The

*Variety of small experiments are running in the institute which caters mainly to the Ph.D. programmes and keep the excitations of small physics vibrant throughout the year.*

device was operated for the first time last year and followed by detailed characterization and wave studies this year. The characterization experiments included experimental study of the unique features of the device. Quiescent magnetized plasma has been obtained over a large operating range,  $5 \times 10^{-5}$  –  $10^{-3}$  mbar and 109 to 1090 G using a unique variable transition magnetic field between the plasma source and the long uniform magnetic field region. The plasma density has been varied over four orders  $10^9$  –  $10^{12}$   $\text{cm}^{-3}$  and temperature by three times 1.5 – 4.5 eV. Probe measurements show that the plasma is radially uniform and axial uniformity extends over 1.2 m in length. The plasma parametric space for which this device was designed has been experimentally achieved. Currently experimental study of nonlinear plasma oscillation leading to phase mixing and wave breaking of plasma oscillation is being carried out. Energy is transferred from wave to plasma using the above mentioned methods and is of use in plasma heating and charge acceleration. Initial experimental results have been encouraging. The importance of these experiments lies in the field of laser fusion, portable plasma based accelerators and controlled fusion in magnetized plasma device.

### A.3.7 Experiments On Dusty Plasma

Vortices occur in a wide range of natural phenomena in nature, like tornadoes, smoke rings etc. Complex plasma provides a conducting environment for studying dust vortices in a controlled laboratory environment. Vortices in complex plas-

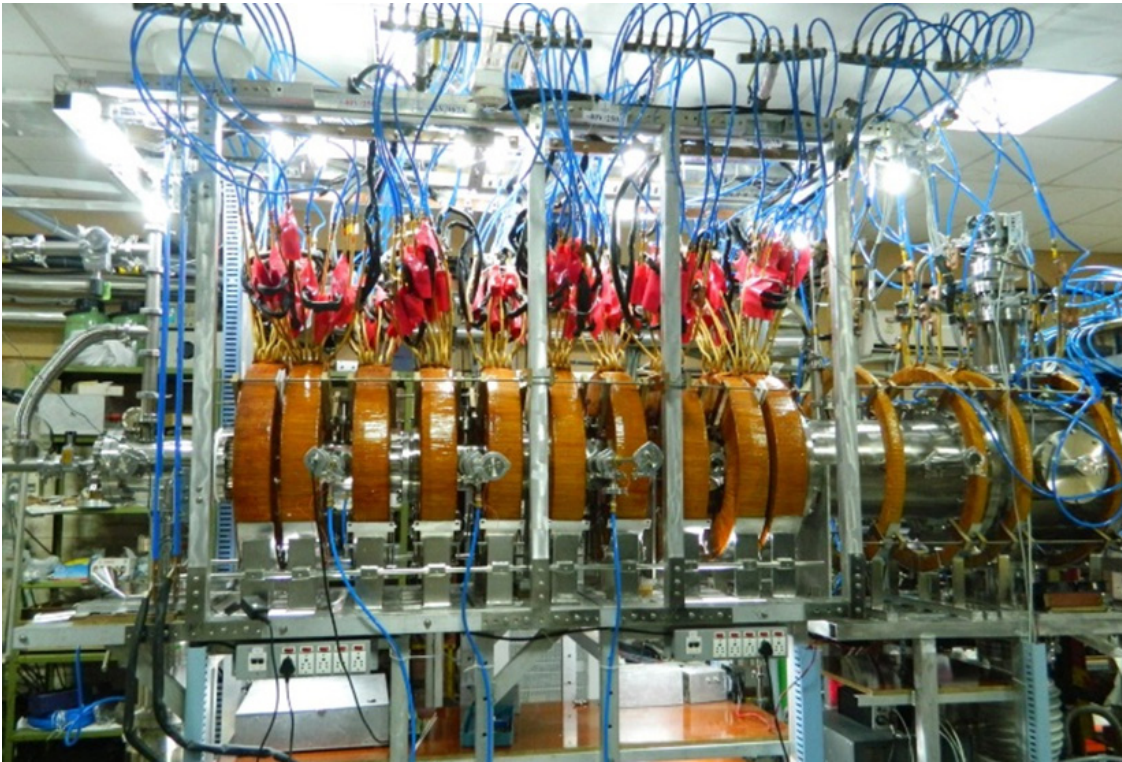

*Figure A.3.6.1  
Picture of Inverse  
Mirror Plasma  
Experimental  
Device (IMPED)  
set up at basic  
plasma laboratory*

plasmas are an ideal test bed for studying the onset of turbulence and collective effects on the very kinetic level. Dust vortices can be produced in laboratory dusty plasma when gravity is compensated by thermophoresis and can be induced externally, for instance, by a laser, by a probe, or by gas flow. Vortices can accompany nucleation and lead to shear flow instabilities. The origin of self-excited vortices in complex plasmas is under discussion. We have experimentally generated dust vortices in an unmagnetized parallel plate DC glow discharge with a metallic ring placed on cathode. The sheath

electric field is used to compensate the gravitational pull acting on the dust particles. The dust vortices are toroidally continuous where the dust particles rotate in the poloidal direction. Our current investigation suggests that the cause behind the rotation of dust particles is the presence of a shear in the ion wind coming towards the cathode surface and a repelling sheath electric field on the surface of cathode. The shear in the ion drag force acts as a torque on the dust particle cloud resulting in the formation of rotating dust structures.

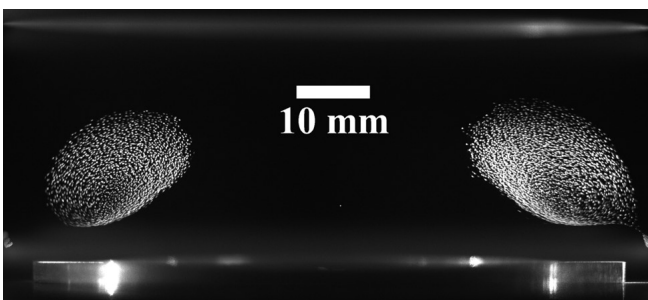

*Figure A.3.7.1 The laser sheet is illuminating the dust torus along its diameter that allows us to see diametrically opposite two poloidal cross-sections which basically look like two vertical dust vortices*

Using hydrodynamic formulation it is observed that the dust rotation can arise due to a gradient in the charge acquired by the dust particles or due to gradient in the ion drag force. The observed vorticity of the dust fluid matches well with that provided by the ion drag gradient instead of charge gradient, corroborating it as the principal cause of rotation. The cause behind the rotation is further strengthened by conducting another experiment involving the generation of additional density gradient. This results into another toroidal dust structure with poloidally rotating dust particles. The evolution of these vortices with discharge parameters such as pressure and discharge current has been studied and results show that the dust particle rotational velocity in both the cases increases.

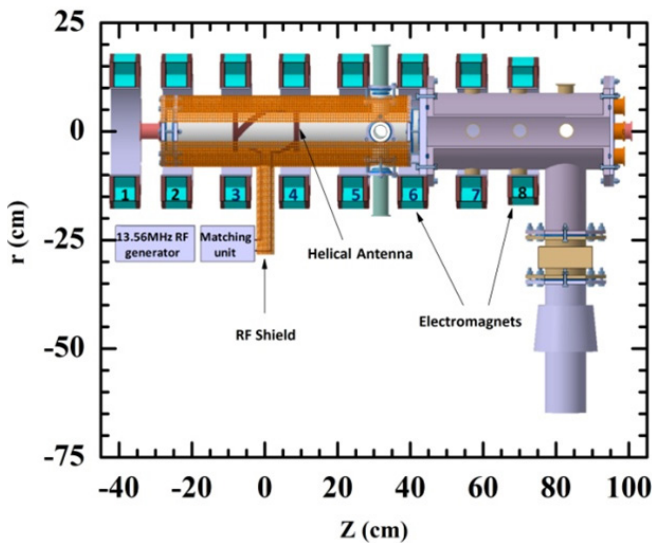

Figure A.3.8.1 3D Schematic of helicon plasma system

### A.3.8 A Linear Helicon Plasma Device with Controllable Magnetic Field Gradient

Helicon Plasma Experiments have been carrying out using a right helicon antenna powered by 13.56MHz RF generator. 3D schematic of the experimental setup is shown in figure (A.3.9). Cold plasma is one in which the thermal speeds of the particles are much smaller than the phase speeds of the waves. Magnetized plasma is a typical anisotropic medium for electromagnetic waves and can support various kinds of waves. Since plasma consists of light electrons and heavy ions, characteristic frequencies range from low frequency ion cyclotron frequency to high frequency electron cyclotron frequency. Important characteristic feature of waves in plasma is that they are subject to damping even in the absence of particle collisions. The collision-less wave damping plays important role in plasma heating (and current drive) which can be effectively used in further raising the temperature of a plasma already having a temperature high enough where the collisional Joule heating is ineffective. A pulse, containing a series of frequencies, the higher frequency waves travels faster, arriving earlier at the detection point than the lower frequency waves and therefore, a whistle of descending pitch is generated, known as whistler waves. Whistler waves in bounded system are called the helicon waves. Role of these helicon waves for inhomogeneous downstream plasma production is studied recently in this helicon plasma system. It is observed that the electrons 30-40 cm away from the antenna

location is heated up due to local damping of propagated helicon waves. Thermal agitation or the randomness is increases for those electrons which are locally heated. Therefore these hot electrons are trying to leave the place with higher velocity than the surrounding cold electrons come to that location. As a result a sink in local density is created, which makes the downstream plasma inhomogeneous. Apart from that the charging at the inner wall of the dielectric glass chamber is studied in this system. The strength of wall charging is more near the antenna rings. The magnitude of RF voltage increases with RF power and causes wall potential to increase.

### A.3.9 Non-Linear Dynamics in DC Glow Discharge Plasma

An experimental system has been developed to study the non-linear dynamics in dc glow discharge plasma. Plasma is produced by applying the dc voltage between two parallel electrodes. Discharge current fluctuations over dc current are measured by current probe and to detect the spatial propagation of ionization wave an array of photodiodes is used. The time series data are taken by varying discharge current, Ar fill pressure and electrode separation. Master students are verifying paschen law for their initial days work with plasma and take I-V characteristics in this dc glow discharge system. Investigation of hysteresis in I-V characteristics, observations of moving and stationary striation are produced and acquired necessary initial data by the M.G university students, Kottayam. Students are also verified the Goldstein–Wehner law holds in the striated positive column of this dc discharge, which state the dependency of striations length, tube radius and pressure. Thickness of stationary striations for different pressures is calculated from these measurements.

### A.3.10 Multi-Cusp Plasma Experiment

All the magnets have been integrated to the experimental chamber and the field mapping has been done. The field values have been verified by analytical calculations as well as commercial softwares. The ionizer plate has been provisionally heated to the half of the required temperature. The target was imaged by infrared Thermography. The heated target plate is observed to have some hot-spots, implying that the heating is not uniform. During this heating exercise it was observed that the assembly and disassembly of the CF flange induced many micro-leaks. Then it was decided to have some modification in the vacuum chamber with an I-type flange in between the main chamber and the reducer. Also the



delivery lines of cesium oven has been modified to have an all-metal leak valve in the path to control the cesium vapour flow. The welding of the final molybdenum nozzles to the moly delivery which will be fixed near the hot plate is being done. After that the whole delivery line from the oven to the nozzle will be tested for uniform temperature profile because any temperature drop on the way might lead to blockage of cesium vapour flow. The indirectly heated probe system has been fabricated and tested for the required temperature and vacuum compatibility. The plasma production will be started very soon.

### A.3.11 Non-Neutral Plasma Experiment (SMARTEX-C)

The High Current DC Power Supply (5000A/100V/1.2s) has been successfully tested and commissioned. A thicker coil with 20 – turns of PTFE coated AWG-8 (70 milli-Ohm) has been wound in order to allow high current from High Current DC Power Supply. The development of bus-bar based TF coils is underway. Capacitive probe signal has been modelled by finding induced charge on the capacitive probe using Green's Reciprocity Theorem. Signal can be modelled for a given input trajectory. The signals obtained for the given trajectory match with the experimental results. Guiding centre trajectory of the electron plasma, while undergoing the Diocotron instability, is obtained using two probe data assuming it to be a point like charge particle. Array of capacitive probes in poloidal plane have been mounted followed by the mode analysis. Experiments on resistive wall destabilization of electron plasma had been carried out in a linear regime of the Diocotron mode. Confinement time scaling experiments were carried out. Diocotron oscillations lasting beyond 1.2s duration have been observed. This confinement time having quiescence lasting for  $> 700\text{ms}$  at very low pressures of  $5.0 \times 10^{-9}$  mbar is larger than electron parallel bounce time scale, toroidal drift time scale and electron-neutral collisional time scale. Diocotron modes were excited using a function generator through a sweep in frequency. A semiconductor-based relay was used to stop the sweep output after desired pulse duration. Controlled diocotron modes were successfully excited for the first time in NNP experimental system.

### A.3.12 Plasma Torch Activities

*Development Work:* High power dc non-transferred plasma torch was designed, developed, and assembled for operation in the range of 50–100 kW using scaling laws developed earlier. Steady-state operation was demonstrated successfully up to 60 kW. Experiments for operation up to 100 kW are in



**Figure A.3.13.1** atmospheric pressure non-transferred dc plasma torch operating at  $\sim 50$  kW, along with power supply and heat exchanger

progress. Miniature enthalpy probe, developed entirely using in-house techniques, was tested for steady state survival inside the plasma torch plume and was used for estimating plasma enthalpy up to torch power of approximately  $\sim 20$  kW. Probe system was enhanced with addition of vacuum pump, digital mass flow controllers and pressure sensor. Exhaustive experiments were conducted. Patent document was prepared and submitted to expert for review.

*Fundamental Studies:* Detailed theoretical investigation of the force balance mechanism in a dc non-transferred plasma torch was carried out. This included extension of the force balance equations to two dimensions and solutions in the presence of externally induced magnetic field, which simulate plasma torch conditions used in our experiments. Numerical solutions of the equations were also obtained. Spectral analysis of the data was carried out, showing the change in anode arc root shunting from random to magnetic field controlled shunting, with the power spectrum shifting from higher to lower frequencies.

*Computational Work:* Steady-state model of the plasma torch, developed under a collaborative project, was used to validate many experimental results. Results obtained using bulk enthalpy probe, which was designed and developed especially for this purpose were also validated. Many other experiments for benchmarking and fine tuning the model were continued. The computer model was also upgraded for self-consistent arc root attachment at the anode.

--!!!--



## A.4. Theoretical, modeling and Computational Plasma Physics

Plasma physics requires a very intense computational capability for its modelling and simulation program. The institute has developed a versatile computational facility in many years. At present work is being done in the the following heads:

A.4.1 Non-Linear Plasma Studies and Simulation	35
A.4.2 Laser Plasma Studies	37
A.4.3 Dusty and/or Complex Plasma Studies	38
A.4.4 Fusion Plasma Studies	39
A.4.5 Global Gyro-kinetic Studies	40
A.4.6 Non-neutral Plasma Studies	40
A.4.7 Molecular Dynamics (MD) Simulations	41

### A4.1 Non-Linear Plasma Studies and Simulation

*Analytical estimate of phase mixing time of longitudinal Akhiezer-Polovin Waves:* Breaking of longitudinal Akhiezer-Polovin (AP) wave is studied analytically and numerically using Dawson sheet model. It is well known that large amplitude AP wave breaks via the process of phase mixing at an amplitude well below the breaking amplitude for AP wave, when subjected to arbitrarily small longitudinal perturbation. We have derived an analytical formula for estimating this phase mixing time scale, which depends on linearly on the phase velocity and inversely on the amplitude of perturbation. This formula has been verified using simulation.

*Fluid Simulation of wake field excited by a relativistic electron beam:* A one dimensional fluid simulation of wake field excited by a relativistic electron beam propagating through a cold plasma has been carried out. The structure of the wake field has been identified as a Akhiezer-Polovin wave, which eventually breaks following a scaling.

*Nonlinear Dynamics of Relativistically intense waves in cylindrical and spherical geometry:* Breaking of relativistically intense space charge oscillation/waves has been investigated analytically and numerically in cylindrical and spherical geometries, using Dawson sheet model. Using a perturbative method based on Lindstedt-Poincare technique, it is found that oscillations/waves in these cases break via phase mixing at much lower amplitude compared to the slab geometry due to additional anharmonicity introduced by geometrical ef-

fects. A numerical code based on sheet model has been written to simulate and verify the scaling of phase mixing time on initial perturbation amplitude.

*Scientific simulation, which provides a natural bridge between theory and experiment, is an essential tool for understanding complex plasma behaviour. Hence the institute has been developing a versatile computational facilities which are ever growing*

*Particle-in-cell simulation of large amplitude ion-acoustic solitons:* The propagation of large amplitude ion-acoustic solitons is studied in the laboratory frame using a 1-D particle-in-cell code that evolves the ion dynamics by treating them as particles but assumes the electrons to follow the usual Boltzmann distribution. It is observed that for very low Mach numbers the simulation results closely match the Korteweg-de Vries soliton solutions, obtained in the wave frame, and which propagate without distortion. The collision of two such profiles is observed to exhibit the usual solitonic behaviour. As the Mach number is increased, the given profile initially evolves and then settles down to the exact solution of the full non-linear Poisson equation, which then subsequently propagates without distortion. The fractional change in amplitude is found to increase linearly with Mach number.

*Observations of transient electric fields in PIC simulation of capacitively coupled discharges:* The analytical prediction of the presence of transient electric field regions between the bulk plasma and sheath edge in radio frequency capacitively coupled plasma (RF-CCP) discharges has been reported before. We have used the semi-infinite particle-in-cell (PIC) simulation technique to verify the theoretical prediction for the existence of transient electric field in the linear regime; it is shown that the PIC simulation results are in good agreement with the results predicted by analytical model in this regime. It is also demonstrated that the linear theory overestimates the transient electric field as one move from linear to weakly nonlinear regime. The effect of applied RF current density and electron temperature on evolution of transition field and phase mixing regime has been explored.

*Effect of mass and charge of ionic species on spatio-temporal evolution of transient electric field in CCP discharges:* The formation of capacitive sheath and existence of the transition electric field between sheath edge and bulk plasma in RF-Capacitively Coupled Plasma discharge is predicted; such structures are sensitive to the plasma composition. On the basis of semi-infinite particle-in-cell (PIC) simulation the effect of charge and mass of ionic species on the spatio-temporal evolution of the transient electric field and phase mixing phenomena in linear and weakly nonlinear regime has been explored. As an important feature, the simulation results predict that the maximum amplitude of the transient electric field decreases with increasing ionic mass and charge; further the sheath width increases with increasing ionic mass while follow opposite trend with increasing ionic charge. The excitation of wave like structures in the transition region and efficient energy transport to the bulk region of CCP discharges in a nonlinear regime has also been predicted.

*Investigation of wave emission phenomena in dual frequency capacitive discharges using particle-in-cell simulation:* Dual frequency capacitively coupled discharges are widely used during fabrication of modern-day integrated circuits, because of low cost and robust uniformity over broad areas. At low pressure, stochastic or collisionless electron heating is important in such discharges. The stochastic heating occurs adjacent to the sheath edge due to energy transfer from the oscillating high voltage electron sheath to electrons. The present research discusses evidence of wave emission from the sheath in such discharges, with a frequency near the electron plasma frequency. These waves are damped very promptly as

they propagate away from the sheath towards the bulk plasma, by Landau damping or some related mechanism. In this work, the occurrence of strong wave phenomena during the expanding and collapsing phase of the low frequency sheath has been investigated. The existence of a field reversal phenomenon, occurring several times within a lower frequency period in the proximity of the sheath is also reported. Electron trapping near to the field reversal regions also occurs many times during a lower frequency period. The emission of waves is associated with these field reversal regions.

*Study of nonlinear structures in collisionless hot plasmas and trapped particle effects:* In collisionless regime, the kinetic effects modify the fast electron response influencing many collective linear and nonlinear processes that are otherwise well described by the equilibrium hydrodynamic formulation of a collisional plasma. The finite amplitude ion acoustic waves that trap electrons modify the structure of the evolving nonlinear soliton solutions. In the numerical simulations, self-consistently generated solitary waves are studied that emerge as a result of a current driven microinstability growing the ion acoustic mode in a collisionless Vlasov plasma. The growth saturates as a result of nonlinear effects governed by a combination of nonlinearities originating from the hydrodynamic model and kinetic particle trapping effects. The resulting solitary waves also coexist with a finite current and an electron plasma wave capable of perturbing the trapping potential. The results of multiscale simulation are analyzed and characterized following the kinetic prescription of undamped trapped particle mode in the form of phase space vortex solutions that are generalized form of Sagdeev's solitons and obey the solutions of a modified Korteweg-de Vries equation, accounting for a stronger nonlinearity originating from the electron trapping.

*Analysis of aging transition in a population of coupled oscillators with delay:* A system of coupled oscillators can display a wide spectrum of collective behavior ranging from synchronization to spatiotemporal chaos and has therefore served as a useful paradigm to represent collective phenomena in a variety of applications in physical, chemical, biological, and social sciences. We investigated the influence of time-delayed coupling on the nature of the aging transition in a system of coupled oscillators that have a mix of active and inactive oscillators, where the aging transition is defined as the gradual loss of collective synchrony as the proportion of inactive oscillators is increased. We start from a simple

model of two time-delay coupled Stuart-Landau oscillators that have identical frequencies but are located at different distances from the Hopf bifurcation point. A systematic numerical and analytic study delineates the dependence of the critical coupling strength (at which the system experiences total loss of synchrony) on time delay and the average distance of the system from the Hopf bifurcation point. We find that time delay can act to facilitate the aging transition by lowering the threshold coupling strength for amplitude death in the system. We then extend our study to larger systems of globally coupled active and inactive oscillators including an infinite system in the thermodynamic limit. Our model system and results can provide a useful paradigm for understanding the functional robustness of diverse physical and biological systems that are prone to aging transitions.

#### A.4.2. Laser-Plasma Studies

*Ion acceleration from laser-irradiated bio-plasmas and solid substrate (with TIFR):* Enhanced electron energies and x-ray emissions from bacteria coated solid substrate in the TIFR experiments directed us to think whether such a biological target can serve as a source of energetic ions. New experiments were carried out to measure ion energies, and surprisingly 10-20 fold increase in Carbon ion energy were obtained

***Through collaboration, the results from the experiments at TIFR, Mumbai are being explained by theory and simulation which are being done by the group at this institute***

from bacteria coated target than a plane glass target. We have set up and run particle-in-cell (PIC) simulations and reproduced some of those experimental results. Detail investigations with respect to peak intensities, laser focal spot size, pulse durations, are still under consideration.

*Understanding of the generation of hard x-rays from laser irradiated bio-plasmas (in collaboration with TIFR):* Earlier TIFR group demonstrated that laser irradiated biological target consisting of a few micron-layer of E. Coli bacteria can lead to bright hard x-ray emissions (up to 300 kilo electron volts) at a moderate laser intensity. Further experiments done in the same group showed that if E.coli bacteria are doped with silver chloride (AgCl) nano-particles x-ray emission can

be enhanced further by 100 times compared to the case with only E.coli. We have reproduced those experimental results by electromagnetic particle-in-cell (EMPIC) simulations at IPR. Our analysis shows that anharmonic resonance absorption is the most dominant mechanism.

*Anomalous collisional absorption of light waves in underdense plasma at low temperature:* Collisional absorption occurs when laser photon energy is transferred to the plasma mainly via the collisions between electrons and ions in the plasma. In this case electron-ion collision frequency plays the role for the laser absorption. Over many years it is known that collision frequency should decrease when plasma temperature is increased or applied laser intensity is increased. Accordingly, fractional absorption, which is defined as the ratio of the absorbed energy to the applied laser energy, of laser pulses in plasma also decreases as temperature increases or intensity increases. However, in some experiments it is found that absorption may also increase with increasing laser intensity. Such an anomalous (meaning unconventional) nature of absorption cannot be explained with existing theoretical model. We have proposed a modified cut-off that depends on the laser frequency and field strength and explained anomalous absorption with quantum and classical models of collision frequency.

*Propagation dynamics of laterally colliding plasma plumes in laser-blow-off of thin film:* A systematic investigation of two plume interactions at different spatial separations (3-7 mm) in laser-blow-off (LBO) induced Li plasmas in ambient argon gas has been carried out. The transport of plasma species from the seed plasmas to the interaction zone is discussed in terms plume divergence, kinetic energy of particles and ion acoustic speed. An attempt is made to understand the formation and dynamics of the interaction zone in the colliding LBO seed plasmas.

*Effect of Electron-Ion Recombination on Self-focusing/defocusing of Laser Pulse in Tunnel Ionized Plasmas:* A formalism for investigation of the propagation characteristics of various order short duration (Pico second) Gaussian/ dark hollow Gaussian laser pulse (DHGP) in a tunnel ionized plasma has been developed, which takes into account the electron-ion recombination. Utilizing the paraxial like approach, a nonlinear Schrödinger wave equation characterizing the beam spot size in space and time has been derived and solved numerically to investigate the transverse focusing (in space) and longitudinal compression (in time) of the laser pulse; the associated energy localization as the pulse advances in the

plasma has also been analyzed. It is seen that in the absence of recombination the DHGP and Gaussian pulse undergo oscillatory and steady defocusing respectively. With the inclusion of recombination, the DHGP and Gaussian pulse both undergo periodic self-focusing for specific parameters. The DHGPs promise to be suitable for enhancement of energy transport inside the plasma.

*Spatiotemporal focusing dynamics in plasmas at X-ray wavelength:* Using a finite curvature beam, we investigate here the spatiotemporal focusing dynamics of a laser pulse in plasmas at X-ray wavelength. We trace the dependence of curvature parameter on the focusing of laser pulse and recognize that the self-focusing in plasma is more intense for the X-ray laser pulse with curved wavefront than with flat wavefront. The simulation results demonstrate that spatiotemporal focusing dynamics in plasmas can be controlled with the appropriate choice of beam-plasma parameters to explore the high intensity effects in X-ray regime.

#### A 4.3 Dusty and/or Complex Plasma Studies

*Study of vapor-liquid phase transition phenomena in dusty plasmas:* The phenomenon of phase transition in a dusty-plasma system (DPS) has attracted some attention in the past. The question of the existence of a vapor-liquid (VL) transition in such a system remains unanswered and relatively unexplored so far. We have investigated this problem by performing molecular dynamics (MD) simulations which show

***The potential applications of dusty plasma physics is tremendous in astrophysical problems as well as in the applied research related to materials sciences. In IPR, both experiments and theory with simulation studies are being pursued vigorously***

that the VL transition does not have a critical curve in the pressure versus volume diagram for a large range of the Yukawa screening parameter ( $\kappa$ ) and the Coulomb coupling parameter ( $\Gamma$ ). Thus the VL phase transition is found to be a continuous transition in the dusty plasma. An approximate analytical explanation of this finding has been given by a simple model calculation.

*Lunar photoelectron sheath and levitation of dust particles:* The decision to launch Luna Glob and Luna Resus satellites, carrying instrumentation to investigate the structure of photoelectron sheath and levitation of dust particles in the sheath, adjacent to the surface of the moon has intensified interest in this exciting area. The profiles of the electric potential, electric field, and electron density in the photoelectric sheath have been evaluated for typical lunar environment and used to obtain the profile of the radius of a dust particle for levitation. The dependence of the electric potential on the surface of the moon on the parameters of the solar wind and photoefficiency of the material of moon's surface has also been discussed. It is seen that the results based on half Fermi-Dirac distribution are significantly different from those obtained on the basis of Maxwell distribution.

*Statistical charge distribution over dust particles in a non-Maxwellian Lorentzian Plasmas:* On the basis of statistical mechanics and charging kinetics, the charge distribution over uniform size spherical dust particles in a non-Maxwellian Lorentzian plasma is investigated. Two specific situations, viz., (i) the plasma in thermal equilibrium and (ii) non-equilibrium state where the plasma is dark (no emission) or irradiated by laser light (including photoemission) are taken into account. The formulation includes the population balance equation for the charged particles along with number and energy balance of the complex plasma constituents. The departure of the results for the Lorentzian plasma, from that in case of Maxwellian plasma, is graphically illustrated and discussed; it is shown that the charge distribution tends to results corresponding to Maxwellian plasma for large spectral index. The charge distribution predicts the opposite charging of the dust particles in certain cases.

*Kinetics of wet Sodium vapor complex plasma:* We have investigated the kinetics of wet (partially condensed) Sodium vapor, which comprises of electrons, ions, neutral atoms, and Sodium droplets (i) in thermal equilibrium and (ii) when irradiated by light. The formulation includes the balance of charge over the droplets, number balance of the plasma constituents, and energy balance of the electrons. In order to evaluate the droplet charge, a phenomenon for de-charging of the droplets, viz., evaporation of positive Sodium ions from the surface has been considered in addition to electron emission and electron/ion accretion. As a significant outcome irradiated, Sodium droplets are seen to acquire large positive potential, with consequent enhancement in the electron density.



*Analysis of the dynamics of charged Dusty fluid in Plasmas:* Small dust particles suspended in a plasma arrange themselves in various phases when locally confined by means of a combination of gravitational and electrostatic fields. These phenomena make the dusty plasma a medium capable of representing a wide range of natural dynamical systems having scales inaccessible to ordinary laboratory. Dynamics of an isothermally driven dust fluid is analyzed which is confined in an azimuthally symmetric cylindrical setup by an effective potential and is in equilibrium with an unconfined sheared flow of a streaming plasma. Cases are analyzed where the confining potential constitutes a barrier for the driven fluid, limiting its spatial extension and boundary velocity. The boundary effects entering the formulation are characterized by applying the appropriate boundary conditions and a range of solutions exhibiting single and multiple vortex are obtained. The equilibrium solutions considered in the cylindrical setup feature a transition from single to multiple vortex state of the driven flow. Effects of (i) the variation in dust viscosity, (ii) coupling between the driving and the driven fluid, and (iii) a friction determining the equilibrium dynamics of the driven system are characterized.

#### A.4.4 Fusion Plasma Studies

*Electron emission induced cooling of boundary region in fusion devices:* We have explored whether the electron emission from the boundary region surfaces (or from additional fine structured dust particles/droplets of some benign material put purposely in the area surrounding the surfaces) can act as an efficient cooling mechanism for boundary region surfaces/dust electrons and hence the lattice. In order to estimate the contribution of this cooling process a simple kinetic model based on charge flux balance and associated energetics has been established. Along with some additional sophistication like suitable choice of material and modification in the work function via surface coating, the estimates show that it is possible to keep the temperature of the plate/particles well within the critical limit, i.e. melting/sublimation point for the desired regime of incident heat flux.

*Kinetics of dust particles around SOL in fusion devices:* A kinetic model based on the balance of charge and energy over the dust particle surface around the scrape off layer (SOL) region in fusion devices has been developed; for describing the dust mass diminution, its temperature evolution and phase change process have been taken into account. The formulation has been utilized to determine the lifetime of cy-

lindrical and spherical dust particles. A realistic situation in fusion devices, when the plasma exhibits meso-thermal flow, has been taken into account. For this purpose a rigorous approach has been adopted to derive the general expressions for the electron (ion) current on cylindrical dust surfaces and the corresponding mean energy of accreting electrons/ions in a flowing plasma. On the basis of analytical modelling the numerical results for the dust electric potential energy and the lifetime of the dust particles corresponding to a typical plasma environment near the SOL region of Mega Ampere Spherical tokamak (MAST)/Joint European Torus (JET) fusion devices have been evaluated for graphite and tungsten dust particles. The results are graphically illustrated as functions of particle size, electron/ion temperature and plasma ionization. It is seen that a large dust particle immersed in low temperature plasma can survive for long time; as an important outcome it is also noticed that the cylindrical particles of tungsten last longer than spherical particles. The findings are of relevance in characterizing and simulating the effects of a variety of dusts for experimental campaigns in large scale (ITER/Demo-like) fusion devices.

*Study of Tearing Modes with equilibrium shear flows:* As a part of ITPA MHD Topical Group joint activity to understand the recent observations of DIII-D that showed the asymmetry in NTM threshold for co and counter toroidal flow, we continue tearing mode simulations using CULHAM Transporter of Ions and Electrons (CUTIE) code. As pure axial flow and poloidal flow did not break symmetry in reference to linear growth rate of tearing modes in presence of co and counter plasma rotation, we have introduced helical flows. Simulation results show that the sign of shear flow matters in presence of helical flows. Then we introduced nonlinear terms in CUTIE equations and get slowing down of linear growth rates due to nonlinear modification of current. We have demonstrated the nonlinear saturation of tearing modes as growth rate becomes zero due to nonlinear effect. However spontaneous symmetry breaking observed for nonlinear saturation levels in case of co and counter pure axial or poloidal flows. These are due to nonlinearly generated helical flow terms and it is an important findings of our observations. Then we have confirmed our two fluid results that the linear modes are more stable in two fluid case compare to single fluid and symmetry breaking is possible for co and counter axial flow cases even in linear two fluid runs.

*Study of Edge Localized Modes with Resonant Magnetic Perturbations:* The dynamics of resonant magnetic pertur-

bations (RMPs) and control of ELMs was studied. We have done CUTIE simulations which show repetitive of ELMs. We have applied  $n=2$  static external magnetic perturbations to study the effect of RMPs on the dynamics of repetitive ELMs. We are getting encouraging results. RMPs seem to redistribute energy of Ballooning-Peeling modes for different mode numbers. As a results of that ELMs are getting mitigated. Then we have to increase the amplitude of RMPs steadily and see some kind of thresholds beyond which transport and confinement changes significantly. However it recovers if we decrease the amplitude of RMPs. If we decrease it to the same earlier value, a hysteresis in states is observed as it holds higher turbulence levels etc.

*Edge-Peeling Ballooning Modes in Tokamaks and Role of Neutral Gas in SOL physics:* A simple two-dimensional (2D) model that consists of electron continuity, quasi-neutrality, and neutral gas continuity equations using neutral gas ionization and charge exchange processes was built to study the role of neutral gas in SOL physics. Simple 1D profile analysis predicts neutral penetration depth into the plasma. Growth rate obtained from the linear theory has been presented. The 2D model equations have been solved numerically. It is found that the neutral gas reduces plasma fluctuations and shifts spectrum of the turbulence towards lower frequency side. The neutral gas fluctuation levels have been studied. The numerical results have been compared with Aditya tokamak experiments.

#### A.4.5 Global Gyro-kinetic Studies

*Gyrokinetic simulations of Micro-tearing Mode in large aspect ratio Tokamaks:* In the first part, taking into account fully gyro-kinetic highly passing ions and electrons, the global 2-D structures of the collisionless micro-tearing mode with full radius coupling of the poloidal modes were obtained. The Electron magnetic drift resonance of the passing electron population is shown to be the main collisionless destabilizing mechanism. The mode grows monotonically with the plasma beta and is strongly electromagnetic as observed from the ratio of fluctuation strengths of magnetic vector potential to the electrostatic potential. Scans at different plasma beta values show an inverse relationship between the temperature gradient length scale and plasma beta leading to a stability diagram, and implying that the mode might exist at moderate to strong temperature gradients for finite beta plasmas in large aspect ratio tokamaks. Real frequency shows a clear

and strong dependence on the plasma beta and beta increases with them. This is in contrast to a nearly constant value found from local-flux tube calculations by others. Linear growth rates from  $n$ -scan and beta scan show that if trapped electrons are neglected, MTMs are more unstable than the Kinetic Ballooning mode. In second part, the role of trapped electrons were investigated. A global gyro-kinetic study including both passing electrons as well as trapped electrons shows that the non-adiabatic contribution of the trapped electrons provide a resonant destabilization, especially at large toroidal mode numbers, for a given aspect ratio. The global 2D mode structures show important changes in the destabilising electrostatic potential. The plasma beta threshold for the onset of the instability is found to be generally downshifted by the inclusion of trapped electrons. A scan in the aspect ratio of the tokamak configuration, from medium to large but finite values, clearly indicates a significant destabilizing contribution from trapped electrons at small aspect ratio, with a diminishing role at larger aspect ratios.

#### A.4.6. Non-Neutral Plasma Studies

*Studies in Pure Electron and Pure Ion Plasmas:* Numerical experiments have been performed to investigate the linear and nonlinear dynamics, and energetics of the ion resonance instability in cylindrically confined non-neutral plasma. The instability is excited on a set of parametrically different unstable equilibria of a cylindrical non-neutral cloud, composed of electrons partially neutralized by a much heavier ion species of single ionization. A particle-in-cell code has been generalized and employed to carry out these simulations. The results obtained from the initial exponential growth phase of the instability in these numerical experiments, are in agreement with the linearized analytical model of the ion resonance instability. As the simulations delve in time much further beyond the exponential growth phase, very interesting nonlinear phenomena of the ion resonance instability are revealed, such as a process of simultaneous wave breaking of the excited poloidal mode on the ion cloud and pinching of the poloidal perturbations on the electron cloud. This simultaneous nonlinear dynamics of the two components is associated with an energy transfer process from the electrons to the ions. At later stages there is heating induced cross-field transport of the heavier ions and tearing across the pinches on the electron cloud followed by an inverse cascade of the torn sections. Work on inclusion of electron-neutral collisions is underway along with efforts to generalize the calculations to

a torus. Heating of collisionless plasmas in closed adiabatic magnetic cycle comprising of a quasi-static compression followed by a non quasi static constrained expansion against a constant external pressure was proposed. Thermodynamic constraints were derived to show that the plasma always gains heat in cycles having at least one non quasi static process. The turbulent relaxation of the plasma to the equilibrium state and the anomalous heating during the non quasi static expansion was discussed and verified via 1D PIC simulation. Applications of this scheme to heating plasmas in mirror machines and tokamaks were suggested.

#### A.4.7 Molecular Dynamics (MD) Simulations

*Nature of Relaxation in Yukawa liquids:* Using high quality molecular dynamics simulation, the role of excess energy in defining an asymptotically reasonable expression for relaxation time was addressed. It was shown that, as the Yukawa liquid is warmed up, the conventional Maxwell relaxation time does not asymptote correctly, while the new definition based on excess energy does. This and the related issues were studied.

*Strongly coupled plasmas under external gravitational field and external temperature gradient - a Molecular Dynamics study:* Using Molecular Dynamics, the important problem of onset and formation of steady Rayleigh-Benard convection. Cells (RBCCs) in strongly coupled Yukawa liquids was investigated. For typical parameters, existence of a critical external temperature difference was demonstrated above which RBCCs are seen to set in. Beyond this critical external temperature difference, the strength of the maximum convective flow velocity was shown to exhibit a new, hitherto unsuspected, linear relationship with external temperature difference, the slope of which was found to be universal. It was found that the time taken for the transients to settle down to a steady state RBCC was found to be maximum, close to the critical external temperature difference and was seen to reduce with increasing external temperature difference. The role of system size, aspect ratio and dust-neutral collisions were also addressed.

*Molecular Dynamics study of Pair-Ion Plasmas - Phase Transition and Transport in Super Critical Regime:* Transport properties near Phase Transition regimes of Pair Ion plasmas has been investigated using Molecular Dynamics simulation for particles interacting via a soft-core Yukawa interaction.

Self-diffusion and related transport properties exhibit anomalous features.

*Study of Kolmogorov Flow In Strongly Coupled 2D Fluids using Generalized Hydrodynamic Model:* The major focus was to understand the role of molecular heating in shear flows. A molecular dynamic study of evolution of Kolmogorov flow in its linear and nonlinear stages was addressed. The results were compared with those of a visco-elastic fluid model. This work is underway.

*Molecular Dynamics studies of Helium bubbles in Fe-Cr Alloys:* Helium (He) produced by transmutation process inside structural materials when irradiated by neutrons plays a vital role in the degradation of material properties. The change in properties of materials subject to irradiation depends on the density and size distributions of the He bubbles formed by diffusive agglomeration of the He atoms. Molecular dynamics (MD) simulations were performed to understand the growth of He bubble in Iron-Chromium alloy to determine the size and structure variation of He bubble inside the host material. Simulations are carried out at two different temperatures, viz. 0.1 K and 800 K, up to He bubble radius of 2.5 nm. Results on the He atomic orientation, bubble growth and dislocation emission were also obtained. An empirical relationship between the volume of He bubbles and number of He atoms at 0.1 K and 800 K was also obtained.

--!!!--

## CHAPTER B

# ACTIVITIES ON OTHER CAMPUSES.

The following are activities done on other campuses and other heads, even though the work done are all under the mandate of the Institute. There are three other campuses at present as following :

B.1 Facilitation Center for Industrial Plasma Technology (FCIPT) Activities .....	43
B.2 ITER-India .....	46
B.3 Center of Plasma Physics(CPP-IPR), Guwahati .....	52



## B.1 Facilitation Center for Industrial Plasma Technologies (FCIPT) Activities

### Plasma Surface Engineering

*Development of plasma carburizing process:* Though plasma carburizing has been discovered in 1934, in the last decade much effort has been devoted to the development of a plasma carburizing process. In India, plasma carburizing process has not yet been developed and efforts were made to develop a prototype plasma carburizing system in FCIPT with the assistance of Department of Science and Technology, New Delhi. In FCIPT, plasma carburizing process was developed using acetylene gas which is cheap compared to methane gas usually employed in plasma carburizing process. The plasma carburizing system consists of a vacuum chamber made of stainless steel. Heaters were installed in the system such that it can go to a maximum temperature of 1050°C. Below the vacuum chamber is the quenching chamber, which is filled with quenching oil. These chambers are separated by a gate valve. Plasma carburizing is usually carried out at 950 - 1050° C. The substrate holder is given a negative bias and the vacuum chamber is given a positive bias. Samples of SAE 8620 are placed on the substrate holder and heated to 950° C. During the process of heating the entire sample became red hot as shown in figure B.1.1 (left). After attaining the required temperature, a gas mixture of acetylene and hydrogen in a fixed ratio is introduced in to the chamber via mass flow controllers. The pressure is maintained between 5-10mbar. Plasma is generated using a pulsed DC power supply having a rating of 20kW. Plasma was formed uniformly on the sample indicating diffusion of carbon ions into the sample as shown in Figure B.1.1 (right). After the required duration, the

voltage is decreased and in the absence of plasma, the samples are heated to 850° C for a required time to allow carbon to diffuse to higher depths. This process is known as diffusion process. Thereafter the gate valve is opened and the sample is dropped in the quenching chamber containing oil. The microhardness profile measured with Vickers hardness tester indicates that the surface hardness has increased to 780HV from the core hardness of 500 HV. The depth of hardening is defined as the depth where the hardness is 550HV. The structure is then 50% martensite and 50% pearlite. The case depth measured is 1000 microns. There is a gradual decrease in hardness from the surface towards the core. The increase in hardness is attributed to the increase in carbon concentration at the surface and the formation of Fe<sub>3</sub>C phase during the plasma carburizing process which was confirmed from XRD analysis. Plasma carburizing is mainly used for applications where hardness, wear resistance and toughness of the surface as well as toughness of the core material are required. Examples are automobile machine parts, such as axles, bolts and gears. From the results we are able to conclude that the plasma carburizing process is able to provide case depths at faster rate as compared to that obtained by the conventional gas and vacuum carburizing processes.

*This activity facilitates a good running relation between the institute and the industries with the latest technological developments in plasma science and technology. In the past, many developed technologies have been commercialized through MOUs with many private industries*

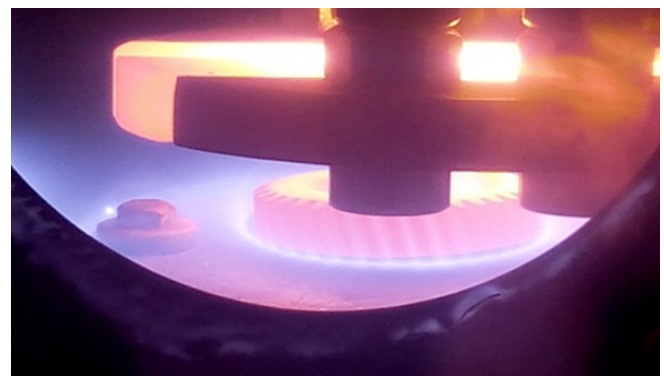

*Figure B.1.1 (left) The sample becomes red hot during the heating process. (right) Plasma surrounding the samples during plasma carburizing process*



**Figure B.1.2 (left) Photograph of an integrated Spacecraft Plasma Interaction eXperiments, SPIX-II facility. (right) Prof. D. Bora, Director, IPR handing over the Project Reports to Mr. R. Ekkundi, Deputy Director, ISAC.**

**Projects funded by ISRO are also being done by sharing the knowledge gained in the plasma science and technology as and when it is required for ISRO missions.**

**Space Plasma & Spacecraft Solar array Interaction study (SPIX-II):** This project on “Spacecraft Plasma Interaction eXperiments, SPIX-II”. has been successfully completed. The objective of this project was to develop an indigenous experimental test facility to simulate LEO and GEO like space conditions in the laboratory. This is the fifth of its kind facility in the world which meets the ISO standards [ISO-11221] established by NASA, USA; ESA, France; and JAXA, Japan. To study the arcing phenomenon in GEO and LEO like environment, series of experiments were carried out on different types of satellite solar panels. Some unique findings were observed and the scientific results are well appreciated among international ESD space science community. A picture of complete SPIX-II facility is shown in figure B.1.2.

**Plasma for food technology:** From the experiments performed in various international laboratories, it has been proved that Plasma can play a vital role in food technology. Considering the future potential of plasma in food technology, a MoU was signed between A. D. Patel Institute of Technology (ADIT), Vallabh Vidyanagar and Institute for Plasma Research (IPR). For the feasibility studies, a compact plasma system has been developed. Few experiments were conducted at ADIT, Vallabh Vidyanagar for the inactivation of E. coli and S. Aureus bacteria.

**Material characterisation of Plasma Hall-Effect Thrusters:** Ceramic wall erosion due to ion beam sputtering is a life-limiting mechanism in Plasma Hall Effect thrusters used in satellites. Owing to relatively long lifetimes of thruster devices, study of sputter erosion of thruster’s ceramic material and its deposition on sensitive equipment such as spacecraft solar cell is important. FCIPT, IPR is working with LPSC (ISRO) on this research problem. An ultra-high vacuum (UHV) facility, equipped with Kaufmann ion source and a rotating quartz crystal microbalance (QCM) sensor, is developed to measure the in-situ differential volumetric sputtering yield of the ceramic material to be used in plasma thrusters. In this research project, Xenon ions are bombarded at multiple angles of incidence, with ion energies starting from 50 eV to 1000 eV, for long hours to exactly simulate the plasma thruster conditions. During ion bombardment, QCM sensor rotates at multiple

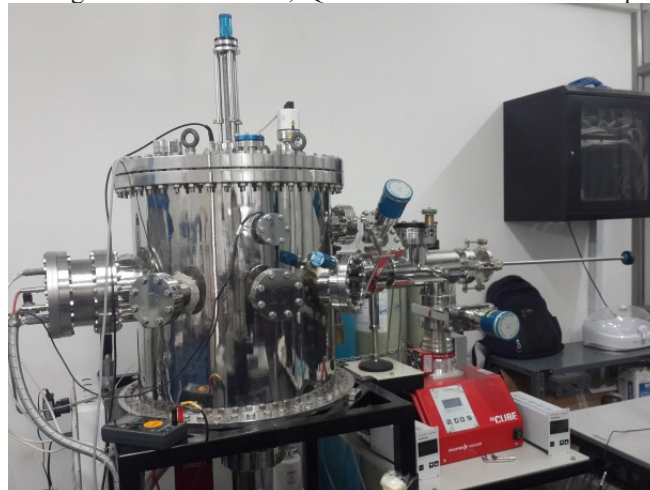

**Figure B.1.3 Developed Ion beam facility**



angles and captures the sputtered material in semi-circular arc. Under this project, facilities are also developed: to map the magnetic field profile inside the thruster at elevated temperatures, to measure of magnetic permeability, and to study surface flashover effects.

*Plasma Material interaction induced surface nanopatterning:* Work is going on two projects funded by DST-Nanomission and DST-Fastrack young scientist scheme. Under these projects, fundamental study of plasma ion interaction with surfaces and generation of various nanoscale features at surface are investigated. Depending on the angle of incidence, ion energy, and fluence, various kinds of nanostructures are formed on the surface as shown below in figure (b). A filament plasma discharge based setup is developed for this study (Figure B.1.4), which is capable to produce a plasma flux of  $1 \times 10^{15} \text{ cm}^{-2}\text{s}^{-1}$  with a provision to bias the substrate up to 2 keV. Typical size of the nanodots is  $\sim 40 \text{ nm}$ , and this size is observed to be increasing with an increase in ion energy. A theoretical model, based on existing sputtering theories, is also developed to simulate the experimentally observed surface topography. The model relies on self-organisation of sputter atoms (during surface erosion), diffusion process, and experimental parameters as inputs. A study is in progress to see the possibility of using these nanopatterns, as templates, to grow ordered silver nanoparticles over them (figure d). These orderly grown nanoparticles find applications in the field of solar cells and molecular sensors etc.

*Feasibility study of alumina coating for solar applications for TATA STEEL:* A feasibility study of depositing alumina coating on uncoated and Ni-coated mild steel substrates, for solar energy applications, was undertaken. This involved deposition experiments using a magnetron source and characterization of the coating. Objective of this study was to explore the possibility of developing insulator coatings (alumina) on mild steel substrates as an interface layer between mild steel and solar cell. This would provide good insulation between the solar cell and metallic substrates. Such applications can prove to be vital for Tata Steel's product development for rural areas.

*Plasma based surface modification to enhance the reliability of prototype Biomedical Implants:* Under a DST funded project, an activity has been started at FCIPT to further improve the reliability of commercially available prototype biomedical implants, using plasma based surface modification. This activity was undertaken in collaboration with CGCRI, Kolkata. In this activity, biocompatible implants – made of

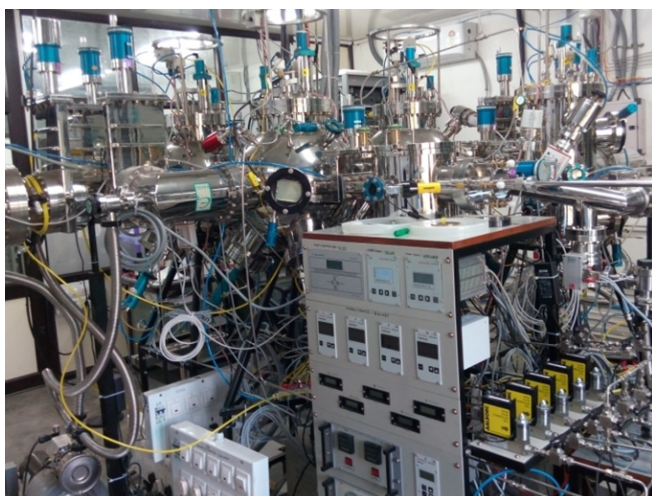

**Figure B.1.4** Developed set up surface nanopatterning

SS 316L and Ti based alloy (Ti-6Al-4V) – will be subjected to (i) plasma nitriding, (ii) magnetron based deposition of Ti/TiN multi-layered coatings, and (iii) combination of the above two; and the effect of these surface modifications on the improvement of their reliability will be studied. The nano-mechanical and nano-tribological properties of plasma nitrided surfaces are expected to improve the reliability of implants. In the first phase of the activity, plasma nitriding was already carried out on the sample materials and their characterization is in progress.

*Development of CZTS based thin film Solar Cell:* Of late, study on the development of low cost thin film based solar cells has become popular in many countries. Especially, thin film solar cells based on Cadmium Telluride (CdTe), Copper Indium Gallium Diselenide (CuInGaSe<sub>2</sub>, also known as CIGS), and Copper Indium Disulphide (CuInS<sub>2</sub>, also known as CIS) have attracted much attention and a lot of work has been carried out. These type of solar cells have shown higher conversion efficiencies ( $\sim 21.7\%$ ) and high optical absorption coefficient ( $\sim 5 \times 10^4 \text{ cm}^{-1}$ ). However, all these type of solar cells have certain limitations such as toxic nature or scarcity of the elements involved. Hence there is a great necessity for the development of thin film absorber coatings, free from Indium and Cadmium etc. Copper Zinc Tin Sulfide (CZTS) is one of the promising materials as an absorber layer in thin film solar cells because of its excellent properties. It has a direct band gap of 1.45 eV, and high absorption coefficient ( $10^4$





**Figure B.1.5** Multi chamber multi magnetron (MCMM) vacuum system installed

cm<sup>-1</sup>). DST has sanctioned a project to FCIPT, under Solar Energy Research Initiative (SERI) programme, for developing a prototype system to produce CZTS based thin film solar cells and to make photovoltaic device. The objective is to see the feasibility of developing a prototype system that can produce CZTS based solar cells of small sizes. After successful demonstration, efforts will be made to develop a large scale commercial system.

**Cell Fabrication Process:** A photograph of the system, which is already installed, is shown in Fig. The system is capable to deposit all the required layers of CZTS solar cell based on magnetron sputtering. It is a multi chamber multi magnetron (MCMM) vacuum system and consists of four vacuum compatible SS chambers. One of the above mentioned four layers is deposited in each of these four chambers. All the chambers can be equipped with a magnetron (in confocal arrangement) for deposition purpose, while in one of the chambers Sulfur can also be vapour deposited (thermal). The sample can be moved from one chamber to another without breaking the vacuum.

**Microwave Coal Gasification Project:** India has huge stock of coal that can generate power for more than 150 years to meet Indian power demand. However, Indian coal has high ash content and low calorific value that increases problems in handling of ash and efficiency matter in power plants. Therefore, coal is imported by power plants because they fall cheaper in terms of energy cost to the plant. There are many other countries where the coal condition is similar to

*To utilize the coal reserves in India effectively, microwave based technology is being developed to create an environment for efficient coal gasification from low calorific value coal that also contains high ash.*

Indian coal. Hence, researchers have been studying for a new technique to extract high ash containing coal energy in best economical viable manner. In this regard, microwave energy has been found most suitable that can create an environment for efficient coal gasification from low calorific value coal that also contains high ash. Microwave provide large and uniform high temperature (1200° C) plasma column with low energy input that helps in converting coal carbon into Syn gas (i.e. Carbon monoxide and Hydrogen) very efficiently. Further, ash does not absorb significant microwave energy and hence, this process can easily handle high ash content coal with selective gasification of carbon from coal. Work is going on to install and commission a small set up (8g/hr) by a 5kW microwave source for studying Indian coal gasification. Another small set up of 1kW microwave plasma torch for 1kg/hr coal gasification is being experimented.

## B.2. ITER-India

In the past one year ITER-India made significant progress in the ITER project. During this period, the ITER-India project has entered into the manufacturing for few packages. The details of the activities completed under different packages/heads are given below.

### B.2.1 In-Wall Shielding (IWS)

The ITER Vacuum Vessel is a double wall structure, and IWS blocks shall be placed between outer and inner shells of Vacuum Vessel (VV) to stop escaping the neutrons and to reduce the toroidal magnetic field ripple. These shielding blocks are made of SS 304B4, SS 304B7, SS 430 and SS 316L (N)-IG and Fasteners (Bolts, Nuts, Spacers, Washers etc.) are made from XM-19 and Inconel-625. The manufacturing of IWS blocks is in progress at Avasarala Technologies Ltd. Bangalore. Nesting plan for Manufacturing of Support Ribs (SRs) and Lower Bracket (LB) for PS1 of all Vessel Sectors (VS), SRs for PS – 2 and PS – 3 of VS – 6 and VS

– 5 were completed. Manufacturing Drawing of support rib & lower bracket assembly of PS-3 and PS-4 of VS-1, 5, 6, 7, 8 & 9 were been completed. Water jet cutting of 90% blocks and 100 % for support ribs for Poloidal Segment-1 (PS-1) was completed. Machining of 22% blocks and 67% of support ribs for PS-1 was completed. Water jet cutting of 22% support ribs for PS-2 and 13% for PS-3 along with machining of 15% and 9% support ribs for PS-2 and PS3 was also completed. Dimensional inspection of PS-1 SRs for VS-6, 5, 4, 3, 2, 1 and Lower welded brackets of PS-1 VS-6, 5 was carried out. Welding of Support Rib & Lower Brackets of PS-1 of VS-6 was done. Manufacturing of In-Wall Shield Plates of PS-1 of VS-6 was completed. Factory Acceptance test of Support Rib & Lower Brackets of PS-1 of VS-6 was carried out. Fabrication of Support Ribs (SR) and Lower Brackets (LB) for PS-2 of VS-6 and PS-1 of VS-5 has been completed. Welding of SR with LB for PS-1 of VS-5 is in progress

### B.2.2 Cryostat & VVPSS

The superconducting magnets operating at 4.5 K in ITER need to be thermally insulated from the environment. to achieve this these magnets are housed in a large vacuum ves-

*ITER, an international project, is an experimental Fusion Reactor being constructed presently at Cadarache, in the South of France. ITER is a step towards future production of electricity from fusion energy*



Figure B.2.1 In-Wall Shielding manufactured blocks

sel (Cryostat) and inside the Cryostat there is an 80 K thermal shield. Cryostat is a reinforced, single walled structure with overall diameter & height ~29 m. The Cryostat transfers all Machine and self loads to the floor during normal and off-normal operating condition. It will be made up with ~ 4000 Metric Tons of austenitic stainless steel. Manufacturing Readiness Review meeting for Cryostat Upper Cylinder, Top Lid, Cryostat Assembly & Installation Tooling, Penetrations & Circular Bellows of upper cylinder was completed. Manufacturing Model and Drawings, Manufacturing & Inspection Plan (MIP) of Cryostat Base section (BS) Tier 1 were completed. Final Design Review for Neutral Beam port duct and port cell bellow was carried out. Cryostat Base section (BS) and Lower Cylinder (LC) mock-up completed and fabrication of Cryostat Base Section sandwich plate started, and completed for BS related jigs and started for BS tier-2. Fabrication of Cryostat Base section Tier-1 & Tier -2 is in progress.

### B.2.3 Cooling Water system

Certain ITER systems/components will be working on specific temperature during the operation, this temperature is needed to be kept in the required margins. Cooling water system is needed to take away heat from the various components/systems and reject this in to the atmosphere. In continuation to the Final Design Review of Lot-1 piping completed last year, the Final Design Review of Lot-2 & Lot-3 piping and the systems has been completed. The final design review covered all aspects with regards to design calculations, analysis, qualification, manufacturability & constructability and manufacturing plan. Following the Manufacturing Readiness

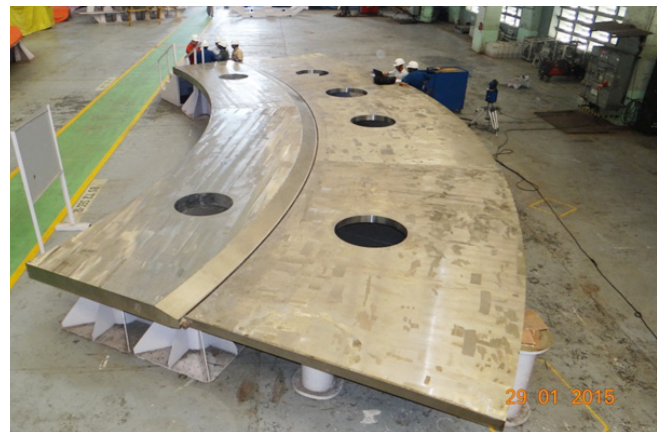

Figure B.2.2 Cryostat Base Section Tier -2 – fabrication in advanced stage





**Figure B.2.3 Unloading of 1800 mm diameter pipe at storage yard**

ness Review of Lot-1 piping, the manufacturing of first lot of piping is nearing completion and is expected to be delivered to ITER site by September 2015. Final Design activities of the entire cooling water system composing of piping and all equipment (pumps, heat exchangers, cooling towers etc.) is under progress and expected to be completed by August

2015. The contractor Larsen & Toubro Chennai has also established a centralized storage/warehousing area at Bavla near Ahmedabad which will serve as a central location for dispatching of piping & equipment to ITER site

**B.2.4 Cryodistribution & Cryolines**

The cryogenics is needed to transport cold power to different components to support and sustain the plasma fusion and to maintain specific systems on working temperature. The cryogenic system also minimizes the heat losses from the superconducting magnets and help to sustain the large current in them. Contracts were awarded for Y+Z Cryolines and cold circulators. Technical bid evaluation for X+Z Cryolines has been completed. Preliminary design activities for Cryolines are in progress and preliminary design review of Y2-group Cryolines has been completed. Manufacturing Design of Test Auxiliary Cold Box (TACB) is in progress. Manufacturing Readiness Review of Prototype Cryoline (Z-Group) is completed with vendor. Manufacturing for Shell structure & dished end of Test Auxiliary Cold Box (TACB) has been completed. Casing manufacturing has been completed for the Test auxiliary Cold Circulators.



TACB thermal shield, TACB Outer Vacuum Jacket & TACB Top Plate with Cryogenic Valve Body inserted

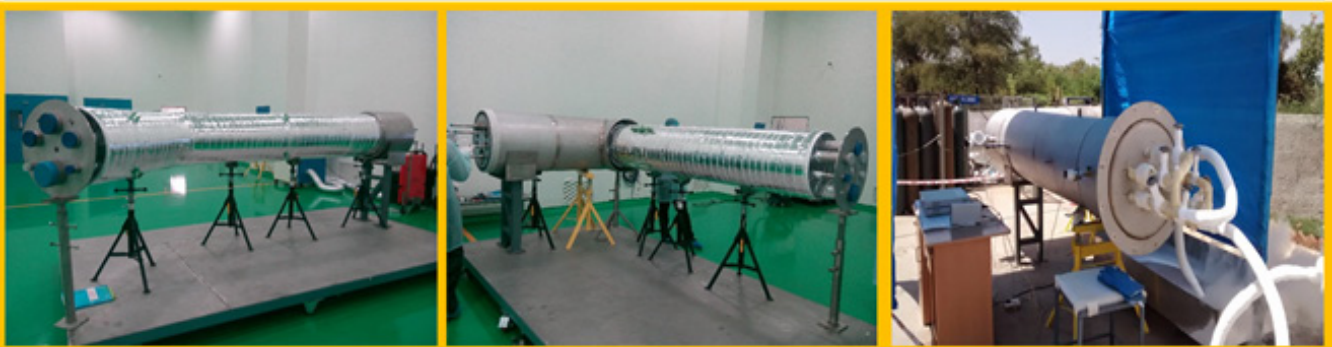

Manufacturing of Prototype Cryoline @ INOX CVA, Testing of Prototype segment is under progress



### B.2.5 Ion Cyclotron Heating & Current Drive Sources

One of the important auxiliary heating and current drive methods for ITER plasma is by using radio frequency waves in the Ion Cyclotron Resonant Frequency (ICRF) range. Total 20 MW of ICRF power will be launched using 8 nos. of sources, each unit of having 2.5 MW/Continuous Wave (CW) capabilities, a Prototype unit is also included in this package for demonstrating the technology. India is responsible for supplying total 9 (1 Prototype and 8 series production) complete ICRF sources for ITER project. To identify the best high power vacuum tube (Diacrode/Tetrode) and other critical components for ITER application, an R&D program has been initiated. Two major contracts have been launched with Thales Electron Devices, France for Diacrode technology and with Continental Electronics Corporation, USA for Tetrode technology, to finalize technical choices of vacuum tube technologies for final stage amplifier. 3MW test rig simulating mis-match load condition is being developed at ITER-India test facility. Extensive tests on the amplifier and auxiliary systems/sub-systems, benchmarking the technical problem in achieving the targeted performance and corresponding up-



Figure B.2.5 Acceptance Tests initiated for Tetrode based system

gradation/modification to the system/sub-systems performed. Standard Factory Acceptance Test (FAT) for Diacrode as well as Tetrode on factory test bench completed successfully. For Diacrode based system, the entire system has stabilized against parasitic oscillation before powering the amplifiers up to 1.5MW RF power level at various frequencies starting from 35 MHz up to 65 MHz for 2000 seconds operation. Further test has been performed for 1.7MW/3600seconds at 36 MHz as extended operation. After successful completion of Factory Acceptance Test (FAT), Diacrode based amplifier system dismantled, properly packed & initiated administrative procedure for shipment to ITER-India, IPR lab for final assembly, integration & testing at full performance. For Tetrode based system, software for controls deployed to hard-

*India is a full partner in the ITER project, in which India would contribute in-kind like cryostat vessel, power supplies, cooling pipe-lines, some diagnostics systems etc which would be designed and manufactured according to international standards.*

ware at supplier's site, integrated with the system and operated for 100kW/2000seconds and 500kW short pulses. Further testing is underway. To test the RF sources as per ITER requirement, a dedicated 3MW/CW test rig is under the final stage of integration at ITER-India, IPR lab. Low power RF section, controls, transmission line sections, RF dummy load, power supplies, low voltage distribution etc. are procured / developed as per ITER need and kept ready for integration with the high power amplifiers. High power RF test at ITER-India test facility will commence from Mid-June 2015, after completion of integration with amplifier system.

### B.2.6 Electron Cyclotron Heating (ECH) system

The EC H&CD system will be used for plasma heating and current drive applications including plasma start up. In this context, the Indian Domestic Agency (ITER-India) has a procurement package (EC Gyrotron Source Package) whose main scope is to supply a set of two high power state of the art Gyrotron sources (170 GHz/1MW/3600s) including their auxiliary systems. The execution approach includes procurement of high power gyrotron tubes on functional specification basis and establishment of complete integrated performance. A Gyrotron Test Facility (IIGTF) with prototype auxiliary systems is being developed to establish the integrated Gy-

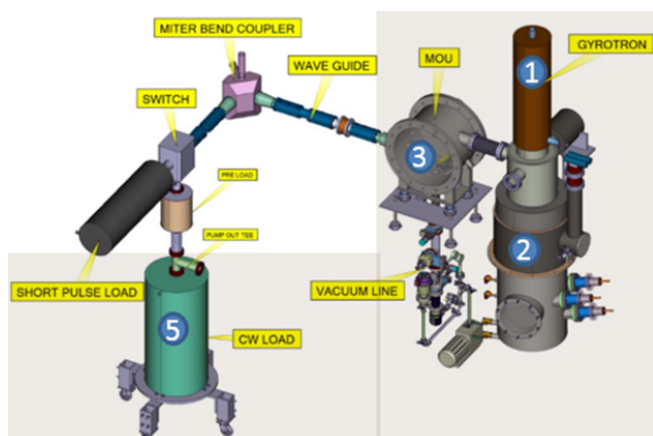

Figure B.2.6 Local Control Unit for Ion Cyclotron Heating test system

tron system performance. Procurement process of Test Gyrotron and waveguide component sets is under progress. For Power Supply and HV Protection system, procurement activities are ongoing Gyrotron Body HV Power Supply. Acceptance tests of HV capacitors have been completed and HV resistors are ready to be delivered in the lab. Initial study has been done on grounding for IIGTF. For Digital Interlock Module, the functional and EMC/EMI tests have been completed giving satisfactory results. Configuration of PLCs, PXIe, Cubicles in control room, SCU modules and chassis in each cubicle, requirement of electrical and optical cables are finalized. UPS has been procured for IIGTF and grounding study is being carried out.

### B.2.7 Diagnostic Neutral Beam (DNB)

The Diagnostic Neutral Beam (DNB) (3 Seconds ON/20 Seconds OFF with 5 Hz modulation) in ITER is mandated to provide 100 kV, ~18-20 Amperes Hydrogen beam to support the Charge Exchange Recombination Spectroscopy (CXRS) for the measurement of Helium ash in the ITER machine. The Factory Acceptance Test of SPIDER Beam Dump was successfully completed at the manufacturer site PVA Tepla, Germany and subsequently delivered to the Neutral Beam Test Facility (NBTF) at Padova, Italy. This is the first in-kind contribution delivery from India to ITER Organization. Fabrication of Vacuum Vessel for DNB Test facility is under final stage at Vacuum Techniques, Bangalore. Manufacturing of DNB Beam Source is in progress at PVA Tepla, Germany. Fabrication of Vacuum Vessel for DNB test facility has also commenced at Vacuum Techniques, Bangalore. DNB Accelerator grid prototype has been manufactured and it is for the

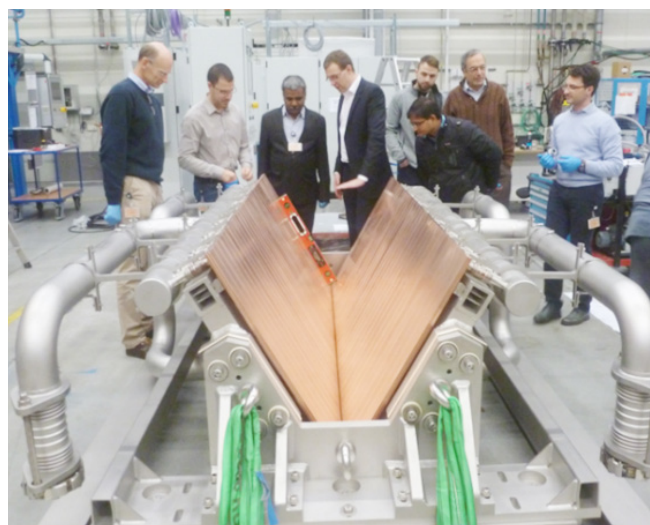

Figure B.2.7 Factory Acceptance Test of Beam Dump first time that such angled grid fabrication has been demonstrated. R&D activities for Twin Source Experiment, Prototype High Voltage Bushing and CuCrZr panel for Residual Ion Dump are ongoing.

### B.2.8 ITER-India, Power Supply Group

The Group is responsible for design, development and supply of various power supplies for DNB, ICH&CD and ECH&CD system of ITER and a high voltage power supply (HVPS) for SPIDER acceleration grid (AG) to be installed at Neutral Beam Test Facility, Padova, Italy. Additionally the group is to develop prototype power supplies to support R&D for the same systems at Iter-India (II) lab. Under manufacturing contract for Acceleration Grid Power Supplies (AGPS) and DNB AGPS to Electronics Corporation of India Ltd. (ECIL); major components of power supply like transformer and SPS modules are manufactured by 'Transformers and Rectifiers' and 'Amtech Electronics' respectively, being ECIL subcontractors. Functional tests and third party tests according to applicable IEC standards are successfully performed. High performance, industry grade PXI based AGPS controller is in house developed. Factory acceptance tests for AGPS with participation of ITER Organization team are due shortly. IC prototype high voltage power supply is successfully commissioned at ITER-India lab; demonstrated for 3MW power with dual output of 27/18kV. Its interfaces with IC source are being established. Dedicated 22kV electrical distribution network is installed at lab, to demonstrate ITER deliverable power supplies. Contract has been awarded for manufacturing of site specific HV deck and transmission line; a part of DNB power supply system.





*Figure B.2.8 Ion Cyclotron prototype high voltage power supply is successfully commissioned at ITER-India lab; demonstrated for 3MW power with dual output of 27/18kV*

### **B.2.9 ITER-India Diagnostics**

For X-Ray Crystal Spectroscopy (XRCS) diagnostics systems, detailed design and analysis of the XRCS Survey sight-tube was developed for Preliminary Design Review (PDR). Thermal, and seismic analysis for were carried out. Neutronics analyses, Monte Carlo Analysis, dose estimation studies were also completed. for the sight-tube composed of Stainless Steel and Aluminium components. Simulation studies were made to develop and define requirements of broadband calibration source. Components are identified for the optical setups for testing crystals and their imaging properties. Procurement of several components for prototype R&D of spectrometer and source has also progressed. For Electron Cyclotron Emission (ECE) diagnostic system, design of prototype transmission line waveguide components has been completed and fabrication of waveguide components is in progress. Preliminary design of a polarizer splitter unit has progressed well. The required vacuum accessories were identified and placed purchase orders. The design and development of a high temperature black body calibration source has been completed and the source is under testing (Figure 1). The fabrication work of the Fourier Transform Spectrometer (FTS) has progressed well at supplier site and likely to be delivered to ITER-India lab in 2015. The design of circular waveguide window assembly for ECE diagnostic has been completed and being reviewed. A circular waveguide taper transition from 2 mm to 19 mm has also been designed, developed and tested in ITER-India lab. Regarding Upper Port # 09, detail designing of Upper Port#09 integration has also progressed towards the System Integration review (SIR) planned for end of 2015. Preliminary Neutronics analysis for

dose rate was completed. Deflection and stresses of Inter-space support structure (ISS) are assessed for the vibrational loads. Beam emission spectroscopy (BES) is a supplementary diagnostic for impurity density measurements along with Charge Exchange Recombination Spectroscopy (CXRS). An alternate proposal is being explored for primary role of CXRS diagnostics along with BES for outer edge region known as CXRS-pedestal.

### **B.2.10 Activities of the Fusion Physics, Information Technology and IO-DA coordination group**

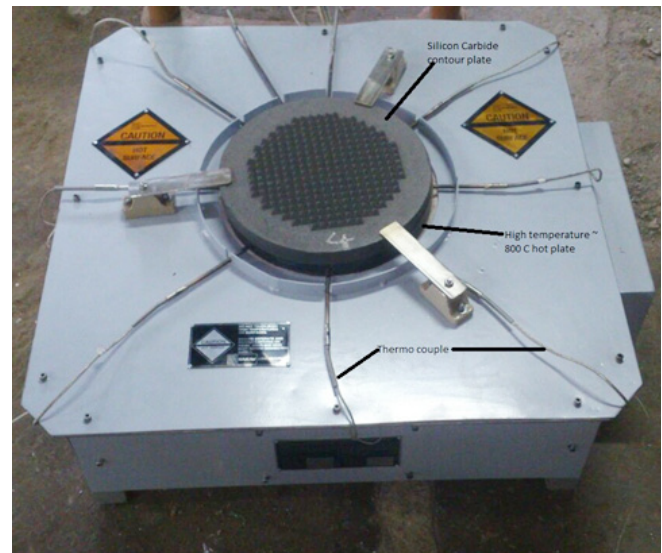

*Figure B.2.9 Indigenously developed high temperature (~ 800 °C) blackbody source for calibration of 70 to 1000 GHz*



Modelling of disruptions in DIII-D and CMOD tokamaks for characterization of Halo currents during disruption and predictions for ITER - this work was started in early 2014 as part of an ITPA activity of MHD working group W10. The IT group continued its efforts in continuous improvement in providing IT services to ITER-India personnel. An online Issue tracker system was implemented as part of the ISO certification activities, which is fully functional now. IT group completed the SAP implementation project at ITER-India. Various improvement of the INDUS documentation server was also carried out.

### ***B.2.11 Activities common to all packages and project office***

Monthly Package review meetings were conducted, budget estimates were prepared and payments were tracked. Regular schedule updates were made and reported at International organization. Ensured compliance to Quality Management System through various documents (Quality plan, Manufacturing & Inspection Plans, Procedures etc.) reviews. Adherence to modern international project management practices and also implementation of Intellectual Property Management (IP) activities through pre-screening of publications for IP and enforcing IP provisions in contracts with industry. ITER-India participated in the ITER IP Contact Persons meeting in October 2014. Extended public awareness activities on fusion were carried out by participating in public exhibitions at Amalthea 2015-Indian Institute of Technology, Gandhinagar, Vibrant Gujarat Global Trade Show 2015, ISDEIV conference Mumbai, FICCI Global R&D Summit - New Delhi. Reporting of the developments to the public was also done through ITER Newslines and ITER Annual Report.

### ***B.2.12 Activities of ITER-India Design Office***

74 Data Exchange Task (DET) were executed between IO and DA and associated technical support was provided. Successful preparation of Cryostat "Parametric Mathematical Model" was carried out to enable quick update of Design Changes in the FEM and hence easy repetition of Analysis for any manufacturing deviations. Also the model was validated by benchmarking the important load conditions. Technical (Design and Analysis) and training (CAD, FEA) support to designers: 15 designers certified for ENOVIA certification. Training on Geometric Dimensioning & Tolerancing (GD&T) training and Advanced ANSYS training was conducted. Design finalization of ECE diagnostic waveguide support structure and component level design validation by analysis for Preliminary Design of the System

was completed. Analyses of Cooling Water System Support structure, ICRF Lab set-up and XRCS sight tube was carried out to validate the design compliance for ITER requirements. CAD Technical Support was provided to designers for CATIA/ENOVIA troubleshooting, CAD methodology, ITER specific CAD/PDM Tool processes. CAD quality checking, ENOVIA CAD data structure management and checking, interface checking of the systems of different packages. Design office carried out System updates and maintenance of resources (Hardware and Software): Software like: CATIA, ENOVIA, 3DVIA, ANSYS, I-RUN, SEE ELECTRICAL EXPERT, CADENAS, AUTOCAD etc. Hardware administration and evaluation was done to satisfy the designers' requirement of complex mathematical computations, analysis and graphics. Videos of ITER-India packages were developed with details using 3DVIA Composer. Regular Participation in Configuration Control Board (CCB) and Technical Meetings was done in support of Change Management with respect to Design development and integration.

## **B.3. Centre of Plasma Physics, Guwahati**

### **B.3.1 Theoretical and Simulation Works**

*Study Of Plasma Deposition in Castellated PFC tile Gaps in Fusion Devices:* Plasma-facing divertors and limiters are armoured with castellated tiles to withstand intense heat fluxes. A 1D – 3V Particle-In-Cell Monte Carlo collision model (XOOPIC) plus a plasma-surface interaction module is applied to study plasma deposition in this critical region. We find a strong asymmetry of plasma deposition into the gaps. A significant fraction of the plasma influx is expelled from the gap to be deposited on the leading edge of the downstream tile.

*Estimation of erosion in the tungsten divertor plates during ELMs:* A 1D – 3V Particle-In-Cell Monte Carlo collision model(XOOPIC) plus a plasma-surface interaction module

***CPP is at Nazirakhat, Sonapur about 32 km. from Guwahati, Assam. This institute was originally established under the Education (Higher) Department of Government of Assam. Now it has been merged with IPR with effect from 29 May 2009***

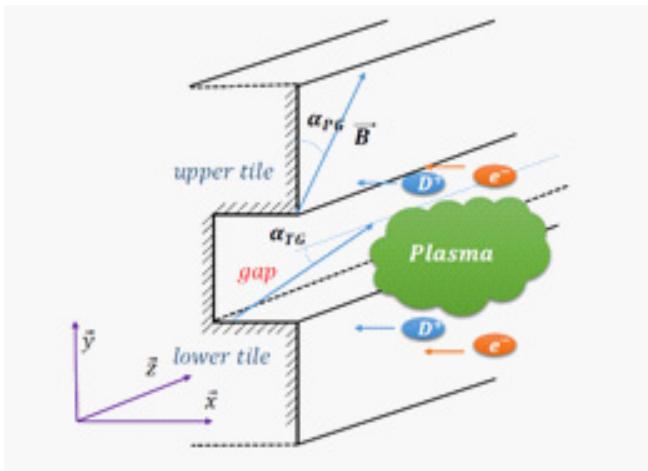

Figure B.3.1 Plasma Deposition in Castellated Plasma Facing Components tile Gaps

is applied to analyse the formation of two dimensional sheath structure in a magnetized plasma. In particular, we have investigated the influence of the angle of incidence of the external magnetic field on formation of sheath and its effect on erosion of divertor armor materials.

*Study of Disappearance of Debye Sheath for angles of a few degrees between the magnetic field and the surfaces:* A limited overview of the theoretical understanding as well as fluid simulation of edge plasmas in fusion devices is given. The effect of grazing angle on solid surface (divertor) erosion due to ion sputtering in magnetic fusion devices is studied by a 1D-3V fluid approach. For an oblique magnetic field, there exists in front of the solid surface a Chodura sheath (CS) (also known as the magnetic pre-sheath) of thickness several ion Larmor radius. The standard assumption is that the CS is additional to the Debye sheath (DS) of thickness several Debye length. For a certain value the grazing angle (a few degree) it has been observed that the DS ceases to exist and the entire potential drop would then occur across the CS. This new analysis of the CS provides solutions for a number of quantities of practical importance, which will improve on the solutions presently in use in models and edge impurity codes.

### B.3.2 Experimental Works

**Inertial Electrostatic Confinement Fusion project:** Portable and cheap neutron sources are on demand for various applications such as in oil and gold mining, cancer therapy, fusion material study, non-invasive interrogation of illicit drugs and explosive materials, identification of impurities in

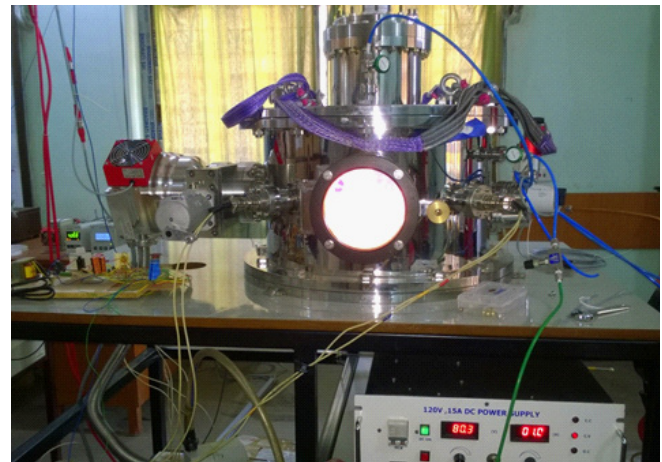

Figure B.3.2 Production of deuterium plasma in Inertial Electrostatic Confinement Fusion device

coal etc. Among the various available neutron sources, inertial electrostatic confinement fusion (IECF) is an extremely compact and simple device that produces high flux of neutrons. The objective is to develop portable neutron sources having linear and spherical geometry which will operate under continuous and repetitive burst mode and produce neutrons at the rate of 100 million to 10 billion per second. Such high flux neutron source is expected to provide the scope to examine the damage occurring in electronic components and in fusion materials. Recently, cylindrical IECF chamber was installed and integrated with all its supporting units namely the turbo molecular pump, gate valve, pressure gauges and residual gas analyzer. Glow discharge plasma in deuterium medium was produced in this device (as shown in Fig.2) and was characterized using optical emission spectroscopy (OES) and Langmuir probes. Deuterium plasma parameters - density and temperature are obtained as  $2.8 \times 10^{15} \text{ m}^{-3}$  and 4.06 eV respectively. Monte-Carlo N-particle simulation (MCNP) for estimating the neutron and gamma radiation mapping for the IECF experiment was carried out recently. The radiation profile of neutron and gamma particles is shown in the Fig. 4 (a) and (b), respectively. Production of neutron from this device will start soon after coupling the high voltage power supply to the IECF chamber.

**The biasing effect of magnetic filter channels on transport of charged particles across the filter field:** In this work, the diffusion process of charged particles across a magnetic field is modified by reducing the electron flow along the field lines through negative potential applied to transverse magnetic filter (TMF) channels in a double plasma device (DPD).

The electrostatic confinement of the electrons along the field lines results in higher diffusion of charged particles across the TMF. The experimentally observed diffusion coefficient is compared with different diffusion processes, predicted in previous experiments. It is observed that in the target region, plasma density can be increased and electron temperature can be decreased with the help of negative biasing of TMF. It is also observed that in the present experimental conditions the diffusion of charged particles across the magnetic field shows consistency with the cross-field Bohm diffusion as long as negative voltage applied to TMF is very low. With an increase in the negative bias voltage, experimental diffusion coefficient deviates from that of Bohm values, associated with an enhanced plasma flow in target region.

#### **Magnetic drift and its effect on cross-field diffusion process:**

In our experimental chamber, from source to target region, due to the transverse magnetic filter (TMF) there exists gradient of density, temperature, plasma potential and magnetic field which may be the prime candidates for various instabilities. The potential gradient from source to the target region creates an axial electric field (E) which is perpendicular to the magnetic field (B), so this may give rise to ExB drift. Again the density gradient from source to the target region may give rise to the diamagnetic drift. In magnetized plasma the cross field diffusion flux is given by Since these drift are not in the axial direction so from earlier literature it is found that researchers have neglected these drift while doing experiment related to the cross field diffusion. Since these radial drift can give rise to drift wave instabilities which can affect the cross field diffusion from source to the target. So understanding of these drift are also very much important in order to get a proper control of various parameters for negative ion production. In order to study the effect of ExB and diamagnetic drift, which is in radial direction, on cross field plasma transport, an experiment is carried out in the double plasma device (DPD). Plasma chamber is divided into two distinct regions, source and target region on the basis of electron temperature, by a transverse magnetic filter (TMF). Plasma is produced in the source region by filament discharge method and diffuses to the target region through the TMF. In order to study the sidewall effect on different plasma parameters a metallic plate is inserted in the TMF region in a direction perpendicular to both the electric (generated due to potential gradient between source and target region) and magnetic fields. Data are taken also in presence and absence of the metallic plate with the help of Langmuir probe.

#### **Experiment with Tungsten and Molybdenum filament for production of low temperature plasma in a double plasma device:**

The effect of wall material on the extracted negative hydrogen ion current is of major interest for negative hydrogen ion source development. In order to study this effect, filaments of different material will be used to produce plasma and the negative ion density measured. Preliminary experiments with different filament wires are being conducted. In the present experiment, Tungsten and Molybdenum wires have been used to produce plasma and the plasma parameters measured.

#### **B.3.3 Thermal Plasma Laboratory**

*Exposing Plansee Tungsten targets in the CPP-IPR High Heat Flux (HHF) system:* We have recently undertaken a series of experiments where tungsten targets were exposed in the CPP-IPR HHF system, with a surface temperature sufficient to cause melting. This system has earlier demonstrated to successfully produce a laminar plasma jet configuration, with more than 10 MW/m<sup>2</sup> level power densities. Scanning Electron Microscopy (SEM) photograph shows that the central portion of a 5 minutes exposed tungsten plate is filled-up densely with so-called hopper or skeletal crystals, with about 20-30 micrometer in sizes. Targets exposed for longer periods (30 minutes) show vertical multi-grain columnar structures.

*CIMPLE-PSI:* This system will reproduce ITER Divertor region like parameters not only in terms of heat flux (10 MW/m<sup>2</sup>), but will simulate similar plasma chemistry with characteristic electron temperature (1-5 eV), ion density (10<sup>20</sup>m<sup>-3</sup>) and ion flux (10<sup>24</sup>m<sup>-2</sup>s<sup>-1</sup>). The system is in an advanced stage of development, with vacuum chamber and vacuum pumps already tested/installed. Fabrication of the water cooled electromagnet (0.4 Tesla) is in active progress, a Kolkata based manufacturer is making the double pancake structures with Luvata, Finland supplied special copper. Installation of an extensive water cooling circuit with cooling tower and plate heat exchanger is almost complete and order placed for the magnet power supply (1000 Ampere, 350 Volt). Installed three numbers of new power panel boards, and overhead trays laid for placing electrical cables. To counter frequent power problem in this locality, a 750 KVA diesel generator is being procured which will be fully dedicated to this experiment only.

--!!!-





## **C. Academic Programme**

C.1 Doctorate Programme .....	56
C.2 Technical Training Programme .....	56
C.3 Summer School Programme.....	56

## **D. Technical Services**

D.1 Computer Services .....	56
D.2 Library Services.....	56
D.3 Mechanical Services.....	57
D.4 Safety Training & Services .....	58

## **E. Publications and Presentations**

E.1 Articles Publications .....	59
E.2 Internal Technical Reports .....	72
E.3 Conference Presentations .....	76
E.4 Invited Talk Delivered by IPR Staff .....	97
E.5 Talks Delivered by Distinguished Visitors at IPR.....	101
E.6 Colloquia Presented at IPR .....	103
E.7 Scientific Meetings Hosted by IPR .....	104
E.8 MoUs Signed .....	105

## **Annexure -I**

Outreach Programme for Public Awareness.....	106
--	-----

## **Annexure - II**

Representation of SCs, STs & OBCs .....	108
---	-----

## C. ACADEMIC PROGRAMMES

### C.1 DOCTORATE PROGRAMME

In the Ph.D. programme conducted by the institute, forty two (42) research scholars have been enrolled at present. Out of them, twenty (20) are working in theoretical and simulation projects while eighteen (18) are engaged in experimental projects. Four (4) new students have joined this programme during the year and are going through the course work. After successful completion of this course work, they will be enrolling for their Ph.D. works. Presently eight (8) Post-Doctoral Fellows are engaged in their research work.

#### Ph.D. Thesis Submitted (during April 2014 - March 2015)

Studies on Thermal-Hydraulics of Plasma Facing Components for SST-1 Tokamak  
Paritosh Chaudhuri  
KIIT University, 2014

Design and developmental aspects of high power ultra-wide-band the ICRF heating in tokamak  
Rana Pratap Yadav  
Homi Bhabha National Institute, 2014

Biased Electrode Experiments in Aditya Tokamak  
Pravesh Dhyani  
Homi Bhabha National Institute, 2014

### C.2 TECHNICAL TRAINING PROGRAMME (TTP)

The IPR TTP program was started from October 2014. There are nine candidates in three branches namely physics, electrical and mechanical (three in each branch). They have undergone a rigorous course work in plasma science and technology and doing their four months project work which will end by October 2015. After their successful completion of course work, they will be absorbed into various projects of IPR like SST1, ADITYA, auxiliary technologies and fusion reactor design etc.

### C.3 SUMMER SCHOOL PROGRAMME (SSP)

Forty six (46) students have participated in this programme out of which 32 students from M.Sc. Physics and (14) stu-

dents from different Engineering disciplines which included Mechanical, Electronics and instrumentation, Electrical, Chemical and Metallurgy. This programme was aimed at providing an opportunity to interact actively with scientists of the institute and learn about Plasma Physics and related areas. They were given exposure through a project and series of lectures. Besides the above-mentioned training programme, project works are routinely offered in Computer, Electronics and Electrical Engineering for regular students as a part of their academic requirements.

## D. TECHNICAL SERVICES

### D.1 Computer Services

The major tasks undertaken by the Computer center during the period were (1) Implementation of Zimbra email system (2) Launching of IPR's new website, (3) Installation of video conferencing facilities at all units of IPR, (4) Tendering process for the 35 Tera Flops high performance computing system (5) First phase of implementation of campus WiFi was completed. (6) RF radio link was established between FCIPT and IPR as a backup for the inter-campus data link. (7) New Blade servers for 24x7 operation of the essential IT services was commissioned. (8) SAN storage system of 10 TB were commissioned to cater to the storage and backup of data for various IT services offered by the computer center. (9) A hardware based Unified Threat Management (UTM) system was installed and commissioned to ensure safe operation of IPR's IT services. Other than these, several other activities have been taken up by the computer center like implementing software tasks for various administrative procedures such as recruitment, CHSS, conference management etc.

### D.2 Library Services

This Library specializes in the areas of Plasma Physics and Fusion Science and Technology. Library is well equipped with modern infrastructure and continues to serve its user community with focused collection and services. Library always act as a catalyst in the research carried out at IPR by making accessible the nascent information resources in various related subject areas. IPR library continued to subscribe to major databases such as SCOPUS, Online Archives of core journals such as Physics of Plasmas and Fusion Science and Technology, and many AIP and APS Journals including PROLA. Library added Online Historical Archives

of Nuclear Fusion and Plasma Physics and Controlled Fusion to its collection. Library has access to SCIEDIRECT through DAE Consortia. Apart from subscribed resources, library has a large collection of in-house electronic resources such as Research and Technical Reports, Reprint, Thesis, etc. These in-house resources and other useful open access resources are made accessible to the user community through library website (<http://www.ipr.res.in/library/>), which acts as a gateway to Plasma Physics and Fusion Information. Library continues to provide current awareness services by delivering current content widely, to plasma physicists at national level. Total 71 News items were displayed as an Alert Service. During reporting period total of Rs. 2,12,52,094.00 budget was utilized. About 537 books and back volumes, 75 internal research reports, 60 technical reports, 34 research reports received from other research institutes, 158 reprints, 34 pamphlets and 35 software were added in to the library collection and subscribed to 103 periodicals. This year a total of 24 only online journals journals were added to e-collection. Library continued to provide Article Delivery Services through Inter Library Loan (ILL) to the user community. 76.34% of the requests made by IPRites were satisfied through Inter Library Loan (ILL) service. IPR Library provided documents to other institutes against their queries and 92.86% of the total need were satisfied. Total 42046 photocopies supplied to users. Library orientation was given to newly joined members, SSP Students, and Research Scholars. Information Literacy activities are regularly carried out for library users.

### D.3 Mechanical Services

**Workshop Services:** It provides the basic mechanical manufacturing and fabrication services as per the requirements given by the users. The workshop has facilities for cutting, welding, milling, turning, etc. Workshop has carried out more than 1176 jobs (small and big) for various groups of the Institute. Apart from this workshop also provides small materials (Approx 3000 kgs) that are kept in its stock for the users for their requirements. Some of the works being done at the workshop involves materials such as Graphite, Ceramic, Lead and Glass-fiber. It is quite difficult to find outside parties who can do these types of jobs and the workshop needs to prepare itself in handling such jobs. *List of the New Machines:* 1. HMT make medium duty lathe machine; 2. Pinacho make small duty lathe machine (with VFD drive). *List of the Major Systems:* 1. Phase shifter transmission line for RF section; 2. Aluminium Rack Assemble for ICRH ; 3. Negative Ion Extraction Chamber for CPP.

**Drafting services:** This caters to the different groups of the institute by generating the necessary drawings. These drawings include conceptual, engineering and fabrication types as well as as-built types. The section is equipped with trained manpower, necessary hardware and software to make the drawings in various platforms that include Auto-CAD, MDT and CATIA, etc. The Drafting section helps in generating engineering drawings for the users for fabrication works to be carried out within the workshop as well as outside.

List of the Major System drawings:-

- Cesium oven for Negative Ion source experiments with 3D and 2D drawing.
- Aditya Upgrade Magnetic probe coil with 3D and 2D dwg and Diamagnetic loop coil with 3D and 2D drawing.
- 3D drawing of gas feed line layout in SST1 hall from the gas feed room up to inside of the vacuum vessel SST1.
- Piping layout of NBI cooling water system (CWS)
- Helicon chamber Assembly for CPP,IPR
- Verified of all PFC module and also Converted PFC model from Inventor to Catia
- Created Catia model for assembly sequence for first wall components.
- Created 3-D model and 2D drawings of Cryostat, Joint Box, Base spacer , Supports, 80k thermal shields, Flanges, Pumping lines and Cooling layouts of Super conducting CS for SST1.
- 2KW Cavity (65-80MHz), 20KW Cavity (65080MHz), and 80KW Cavity (65-80MHz) assembly for High Power ICRH System Division.
- SMARTEX EXPERIMENT device Assembly of Non Neutral plasma For NNP/Basic Science.

**Water Cooling and Air Conditioning Services:** This caters to water cooling and the air conditioning requirements of the different groups of the institute. The following are the completed tasks : (a) Commissioning of 125 TR Daikin make Screw Chillier for SST-1 Central AC System; (b) Commissioning of DX AHU AC system for APPS Lab; (c) Vortex Flow Meters installation and signal cabling work for SST LHCD WDS system; (d) Provided Water Cooling connection to ITER DNB system; (e) Handled cool down campaigns of SST-1, N-NBI and ITER-ICRH. The following are the ongoing works : (a) Precision Air-conditioning system for TEM Lab, FCIPT; (b) SST Vacuum N2 baking Exhaust and Ventilation system; (c) IPR Canteen HVAC, Exhaust and Ventilation work; (d) RHVPS Lab DX AHU AC System; (e) Finalization of PEB building HVAC design and tender documents in coordination with architect .



**D.4 Safety Training and Services**

Safety Training Conducted in the Institute

<b>Sr. No.</b>	<b>Training Name</b>	<b>No. of persons attended</b>	<b>Date</b>
1	Safety Induction Training	14	01 & 02-05-2014
2	Safety Induction Training	19	01 & 02-12-2014
3	Functioning and Operating of Self-Contained Breathing Apparatus (SCBA)	6	11/26/2014
4	Practical Demonstration of Operating of Fire Equipments for Employees of IPR, FCIPT and ITER-India	63	27 & 28-11-2014
5	Practical Demonstration of Fire Hydrant system installed at ITER-India Laboratory Building	32	2/19/2015
6	Practical Demonstration of Fire Alarm system installed at IPR for Security Staff	21	4/21/2014
7	Practical Demonstration of Fire Alarm system installed at ITER-India Laboratory Building for Security Staff	12	4/29/2014
8	Practical Demonstration of Operating of Fire Equipments for Security Staff of IPR	44	8/6/2014
9	Practical Demonstration of Operating of Fire Equipments for Security Staff of IPR	41	11/27/2014
10	Practical Demonstration of Operating of Fire Equipments for Security Staff of FCIPT and ITER-India	15	11/28/2014
11	First Aid Training for the Employees	30	11/14/2014
12	Safety Awareness Program for the Employees of CPP-IPR	25	8/21/2014
13	Training on “”Defensive Driving”” for Contract Drivers	23	1/16/2015
14	Functioning and Operating of Self-Contained Breathing Apparatus (SCBA)	13	3/30/2015

--!!!--

## E. PUBLICATIONS AND PRESENTATIONS

### E.1 Articles Publications

#### E.1.1 Journal Articles

Constitutive Flow Behavior of IFAC-1 Austenitic Stainless Steel Depicting Strain Saturation over a Wide Range of Strain Rates and Temperatures

DIPTI SAMANTARAY, ALPESH PATEL, UTPAL BORAH, S.K. ALBERT, A.K. BHADURI

**Materials and Design, 56, 565-571, 2014**

Gravitational Waves from Known Pulsars: Results from the Initial Detector Era

J. AASI *et al* (*LIGO Scientific Collaboration, Virgo Collaboration, and IPN Collaboration*)

**Astrophysical Journal, 785, 119, 2014**

Role of Secondary Emission on Discharge Dynamics in an Atmospheric Pressure Dielectric Barrier Discharge

W. H. TAY, S. S. KAUSIK, S. L. YAP and C. S. WONG

**Physics of Plasmas, 21, 044502, 2014**

Reduced Leakage Current of Multiferroic BiFeO<sub>3</sub> Ceramics with Microwave Synthesis

V. RAGHAVENDRA REDDY, DEEPTI KOTHARI, SANJAY KUMAR UPADHYAY, AJAY GUPTA, N. and CHAUHAN, A.M. AWASTHI

**Ceramics International, 40, 4247-4250, 2014**

Overall Performance of SST-1 Tokamak Vacuum System

ZIAUDDIN KHAN, FIROZKHAN S. PATHAN, SIJU GEORGE, KALPESH R. DHANANI, PARAVASTU YUVAKIRAN, PRATIBHA SEMWAL, GATTU R. BABU and SUBRATA PRADHAN

**IEEE Transaction on Plasma Science, 42, 1006-1011, 2014**

Chimera States: The Existence Criteria Revisited

GAUTAM C. SETHIA and ABHIJIT SEN

**Physical Review Letters, 112, 144101, 2014 (IPR/RR-628/2013)**

Effect of Polarization and Focusing on Laser Pulse Driven Auto-Resonant Particle Acceleration

VIKRAM SAGAR, SUDIP SENGUPTA and PREDHIMAN KAW

**Physics of Plasmas, 21, 043102, 2014 (IPR/RR-633/2014)**

Effect of Organic Ligands (L-Proline and L-Methionine) on Growth, Structural, Vibrational, Crystalline Perfection, SHG Efficiency, Microscopic and Optical Properties of KDP Single Crystals

MOHD SHKIR, B. RISCOB, M. AJMAL KHAN, S. ALFAIFY, ERNESTO DIEGUEZ and G. BHAGAVANNARAYANA

**Spectrochimica Acta Part A: Molecular and Biomolecular Spectroscopy, 124, 571-578, 2014**

An analytic Approach to Modeling the Optical Response of Anisotropic Nanoparticle Arrays at Surfaces and Interfaces

L PERSECHINI, R VERRE, N MCALINDEN, J. J. WANG, M RANJAN, S FACSKO, I V SHVETS and J F MCGILP

**Journal of Physics: Condensed Matter, 26, 145302, 2014**

Improved Performance of Two-Way Power Divider using Dielectric Resonator

AKHILESH JAIN, P. R. HANNURKAR, S. K. PATHAK, ANIMESH BISWAS and MRIGANK SRIVASTVA

**Microwave and Optical Technology Letters, 56, 858-861, 2014**

Shock Waves in a Dusty Plasma having q-nonextensive Electron Velocity Distribution

KAUSHIK ROY, PRASANTA CHATTERJEE, S. S. KAUSIK and C. S. WONG

**Astrophysics and Space Science, 350, 599-605, 2014**

An Overview of Spacecraft Charging Research in India: Spacecraft Plasma Interaction Experiments-SPIX-II

GUPTA, S.B., KALARIA, K.R., VAGHELA, N.P., MUKHERJEE, S., JOSHI, R.S., PUTHANVEETIL, S.E., SHANKARAN, M. and EKKUNDI, R.S.

**IEEE Transactions on Plasma Science, 42, 1072-1077, 2014 (IPR/RR-572/2012)**

Effect of Cobalt Doping on the Structural, Microstructure and Microwave Dielectric Properties of MgTiO<sub>3</sub> Ceramics Prepared by Semi Alkoxide Precursor Method

THATIKONDA SANTHOSH KUMAR, PALLABI GOGOI, ALAGARSAMY PERUMAL, PRAMOD SHARMA and DOBBIDI PAMU

**Journal of the American Ceramic Society, 97, 1054-1059, 2014**

Constraints on Cosmic Strings from the LIGO-Virgo Gravitational-Wave Detectors

J. AASI *et al* (*LIGO Scientific Collaboration, Virgo Collaboration, and IPN Collaboration*)

**Physical Review Letters, 112, 131101, April 2014**

Properties of Gravitationally Equilibrated Yukawa Systems-  
A Molecular Dynamics Study  
HARISH CHARAN, RAJARAMAN GANESH and ASH-  
WIN JOY

**Physics of Plasmas, 21, 043702, 2014**  
**(IPR/RR-635/2014)**

Plasma Anusandhan Sansthan-Ek Parichay (In Hindi)  
DHIRAJ BORA  
**Aavishkar, 44, 3, 2014**

Plasma-Paryavaran Sanrakshan me Kuch Upyog (In Hindi)  
SURYAKANT B. GUPTA  
**Aavishkar, 44, 6, 2014**

Bharat me Sanlayan Anusandhan Karyakram (In Hindi)  
SHISHIR DESHPANDE and P.K. KAW  
**Aavishkar, 44, 13, 2014**

Plasma par Kuch Maulik Prayog (In Hindi)  
PRABAL KUMAR CHATTOPADHYAY, A. V. RAVIKU-  
MAR, RAMASUBRAMANIAN, R. GANESH, B. GAN-  
GULI and SHANTANU KUMAR KARKARI  
**Aavishkar, 44, 19, 2014**

Tokamak-Nabhikiya Sanlayan Urja ki Sashakt Machine (In  
Hindi)  
MOHAMMAD SHOAIB KHAN  
**Aavishkar, 44, 24, 2014**

Sanlayan Plasma me Prakshobh ke Prabhav (In Hindi)  
AMITA DAS and P.K. KAW  
**Aavishkar, 44, 28, 2014**

Aditya-Swadeshi Tokamak (In Hindi)  
RATNESHWAR JHA and KUMUDINI TAHILIYANI  
**Aavishkar, 44, 32, 2014**

Sanlayan Neutroniki-Neutron Abhigaman Ganana (In Hindi)  
TEJEN KUMAR BASU  
**Aavishkar, 44, 39, 2014**

Application of a Hough Search for Continuous Gravitational  
Waves on Data from the Fifth LIGO Science Run  
J. AASI, AND A. KUMAR et al  
**Classical and Quantum Gravity, 31, 085014, 2014**

Kinetics of Wet Sodium Vapor Complex Plasma  
S. K. MISHRA and M. S. SODHA  
**Physics of Plasmas, 21, 043703, 2014**

Design and Development of Ultra-Wideband 3 dB Hybrid  
Coupler for Ion Cyclotron Resonance Frequency Heating in  
Tokamak  
RANA PRATAP YADAV, SUNIL KUMAR and S. V.  
KULKARNI  
**Review of Scientific Instruments, 85, 044706, 2014**  
**(IPR/RR-631/2014)**

Effect of Flux Addition on Mechanical and Microwave Di-  
electric Properties of Barium Zinc Tantalate Ceramics  
SWATHI MANIVANNAN, V. S. SURYA CHANDRA, P. K.  
SHARMA, K. C. JAMES RAJU and DIBAKAR DAS  
**Transactions of the Indian Ceramic Society, 73, 87-89,**  
**2014**

Characterization and Calibration of 8-Channel E-Band Het-  
erodyne Radiometer System for SST-1 Tokamak  
VARSHA SIJU, DHARMENDRA KUMAR, PRAVEENA  
SHUKLA and S. K. PATHAK  
**Review of Scientific Instruments, 85, 053503, 2014**

Argon-Oxygen dc Magnetron Discharge Plasma Probed with  
Ion Acoustic Waves  
PARTHA SAIKIA, BIPUL KUMAR SAIKIA, KALYAN  
SINDHU GOSWAMI and ARINDAM PHUKAN  
**Journal of Vacuum Science and Technology A: Vacuum,**  
**Surfaces and Films, 32, 031303, 2014**

Spatial Analysis of Impurities on the Surface of Flange and  
Optical Window of the Tokamak using Laser Induced Break-  
down Spectroscopy  
GULAB SINGH MAURYA, ARADHANA JYOTSANA,  
ASHOK KUMAR PATHAK, AJAI KUMAR, and AWAD-  
HESH K. RAI  
**Optics and Lasers in Engineering, 56, 13-18, 2014**

Theoretical Study of Head-On Collision of Dust Acoustic  
Solitary Waves in a Strongly Coupled Complex Plasma  
S. JAISWAL, P. BANDYOPADHYAY and A. SEN  
**Physics of Plasmas, 21, 5, 053701, 2014**  
**(IPR/RR-648/2014)**

Plasma Heating by Electric Field Compression  
K. AVINASH and P.K. KAW  
**Physical Review Letters, 112, 185002, 2014**  
**(IPR/RR-579/2012)**



Search for gravitational wave ringdowns from perturbed intermediate mass black holes in LIGO-Virgo data from 2005-ating by electric field compression2010

J. AASI *et al* (*LIGO Scientific Collaboration, Virgo Collaboration, and IPN Collaboration*)

**Physical Review D, 89, 102006, 2014**

Design and implementation of quench detection instrumentation for TF magnet system of SST-1

Y. KHRISTI, A.N. SHARMA, K. DOSHI, M. BANAUDHA, U. PRASAD, P. VARMORA, D. PATEL, and S. PRADHAN

**Fusion Engineering and Design, 89, 623-627, 2014**

Design and implementation of data acquisition system for magnets of SST-1

K. DOSHI, S. PRADHAN, H. MASAND, Y. KHRISTI, J. DHONGDE, A. SHARMA, B. PARGHI, P. VARMORA, U. PRASAD, and D. PATEL

**Fusion Engineering and Design, 89, 679-683, 2014**

Embedded Linux platform for data acquisition systems

JIGNESHKUMAR J. PATEL, NAGARAJ REDDY, PRAVEENA KUMARI, RACHANA RAJPAL, HARSHAD PUJARA, R. JHA and PRAVEEN KALAPPURAKKAL

**Fusion Engineering and Design, 89, 684-688, 2014**

Kinetics of Dust Particles around the Scrape off Layer in Fusion Devices

S K MISHRA, SHIKHA MISRA and M S SODHA

**Plasma Physics and Controlled Fusion, 56, 055005, 2014**

Feasibility of ECE Measurements using Hilbert-Transform Spectral Analysis

YURIY DIVIN and HITESH KUMAR B. PANDYA

**Fusion Science and Technology, 65, 399-405, 2014 (IPR/RR-613/2013)**

Influence of Prior Fatigue Cycling on Creep Behavior of Reduced Activation Ferritic-Martensitic Steel

ARITRA SARKAR, V. D. VIJAYANAND, P. PARAMESWARAN, VANI SHANKAR, R. SANDHYA, K. LAHA, M. D. MATHEW, T. JAYAKUMAR, and E. RAJENDRA KUMAR

**Metallurgical and Materials Transactions A: Physical Metallurgy and Materials Science, 45, 3023-3035, 2014**

A Guillemin Type E pulse Forming Network as the Driver for a Pulsed, High Density Plasma Source

PRIYAVANDNA J. RATHOD, V. P. ANITHA, Z. H. SHOLAPURWALA and Y. C. SAXENA

**Review of Scientific Instruments, 85, 063503, 2014**

Noise Mitigation in Thermocouple Signal Conditioning System for Neutral Beam Calorimeter for NBI SST-1

BANSAL, L.K., PATEL, P.J. ; QURESHI, K. ; PATEL, V.B. ; GUPTA, L.N. ; THAKKAR, D.P. ; SUMOD, C.B. ; VADHER, V. ; PARMAR, S.L. ; BHARATHI, P. ; VATTIPALLE, P. and BARUAH, U.K.

**IEEE Transactions on Plasma Science, 42, 6819055, 1780-1784, 2014**

Slow Excited State Phototautomerization in 3-Hydroxyisoquinoline

NEERAJ KUMAR JOSHI, PRIYANKA ARORA, SANJAY PANTA and HEM CHANDRA JOSHI

**Photochemical and Photobiological Sciences, 13, 929-938, 2014**

First Engineering Validation Results of SST-1 TF Magnet System

SUBRATA PRADHAN, K. DOSHI, A. SHARMA, U. PRASAD, Y. KHRISTI, V. TANNA, ZIAUDDIN KHAN, A. VARADHARAJALU, D. SHARMA, M. VORA, A. SINGH, B. PARGHUI, M. BANAUDHA, J. DHONGDE, P. VARMORA and D. PATEL

**IEEE Transaction on Applied Superconductivity, 24, 4202206, 2014**

Performance of Joints in SST-1 Magnets

UPENDRA PRASAD, AASHOO SHARMA, KALPESH DOSHI, YOHAN CHRISTIAN, DIPAK PATEL, PANKAJ VARMORA, ZIAUDDIN KHAN, VIPUL TANNA, and SUBRATA PRADHAN

**IEEE Transaction on Applied Superconductivity, 24, 4801704, 2014**

The Removal of Impurities from Gray Cotton Fabric by Atmospheric Pressure Plasma Treatment and its Characterization using ATR-FTIR Spectroscopy

HEMEN DAVE, LALITA LEDWANI, NISHA CHANDWANI, NARENDRASINH CHAUHAN, and S.K. NEMA

**The Journal of the Textile Institute, 105, 586-596, 2014**

The NINJA-2 project: Detecting and Characterizing Gravitational Waveforms Modelled using Numerical Binary Black Hole Simulations

J. AASI *et al* (*LIGO Scientific Collaboration, Virgo Collaboration, and IPN Collaboration*)

**Classical and Quantum Gravity, 31, 115004, 2014**

Search for Gravitational Waves Associated with  $\gamma$ -ray Bursts

Detected by the Interplanetary Network

J. AASI *et al* (*LIGO Scientific Collaboration, Virgo Collaboration, and IPN Collaboration*)

**Physical Review Letters, 113, 011102, 2014**

Search for gravitational radiation from intermediate mass black hole binaries in data from the second LIGO-Virgo joint science run

J. AASI *et al* (*LIGO Scientific Collaboration, Virgo Collaboration, and IPN Collaboration*)

**Physical Review D, 89, 122003, 2014**

Methods and results of a search for gravitational waves associated with gamma-ray bursts using the GEO 600, LIGO, and Virgo detectors

J. AASI *et al* (*LIGO Scientific Collaboration, Virgo Collaboration, and IPN Collaboration*)

**Physical Review D, 89, 122004, 2014**

Study on Neutron Emission from 2.2 kJ Plasma Focus Device

N. TALUKDAR, N. K. NEOG and T. K. BORTHAKUR

**Physics of Plasmas, 21, 062709, 2014**

Suppression of Rayleigh Taylor Instability in Strongly Coupled Plasmas

AMITA DAS and PREDHIMAN KAW

**Physics of Plasmas, 21, 062102, 2014**  
(IPR/RR-608/2013)

A Semi-Analytic Power Balance Model for Low (L) To High (H) Mode Transition Power Threshold

R. SINGH, HOGUN JHANG, P. K. KAW, P. H. DIAMOND, H. NORDMAN, C. BOURDELLE and A. LOARTE

**Physics of Plasmas, 21, 062503, 2014**

Recent Improvements in the EMC3-Eirene Code

Y. FENG, H. FRERICHS, M. KOBAYASHI, A. BADER, F. EFFENBERG, D. HARTING, H. HOELBE, J. HUANG, G. KAWAMURA, J. D. LORE, T. LUNT, D. REITER, O. SCHMITZ, and D. SHARMA

**Contributions to Plasma Physics, 54, 426-431, 2014**

Dynamics of Multiple Double Layers in High Pressure Glow Discharge in a Simple Torus

MANASH KUMAR PAUL, P. K. SHARMA, A. THAKUR, S. V. KULKARNI, and D. BORA

**Physics of Plasmas, 21, 062112, 2014**

Transport Driven Plasma Flows in the Scrape-Off Layer of

ADITYA Tokamak in Different Orientations of Magnetic Field

DEEPAK SANGWAN, RATNESHWAR JHA, JANA BRO-TANKOVA, and M. V. GOPALKRISHNA

**Physics of Plasmas, 21, 062512, 2014**

Optical Time of Flight Studies of Lithium Plasma in Double Pulse Laser Ablation: Evidence of Inverse Bremsstrahlung Absorption

V. SIVAKUMARAN, H. C. JOSHI, R. K. SINGH, and AJAI KUMAR

**Physics of Plasmas, 21, 063110, 2014**

Thermal Cycling Behavior of Alumina-Graphite Brazed Joints in Electron Tube Applications

N. DANDAPAT, S. GHOSH, KALYAN SUNDAR PAL, S. DATTA, and B.K. GUHA

**Transactions of Nonferrous Metals Society of China, 24, 1666-1673, 2014**

Al<sub>2</sub>O<sub>3</sub> Films Grown by Glow Discharge Plasma Aluminising

N. I. JAMNAPARA, V. NAYAK, D. U. AVTANI, N. L. CHAUHAN, D. PANDA, S. B. GUPTA, K. KALARIA, N. VAGHELA, S. MUKHERJEE, and A. S. KHANNA

**Surface Engineering, 30, 467-474, 2014**

Analysis of Deposited Impurity Material on the Surface of the Optical Window of the Tokamak using LIBS

GULAB SINGH MAURYA, ARADHANA JYOTSANA, ROHIT KUMAR, AJAI KUMAR and A K RAI

**Physica Scripta, 89, 075601, 2014**

Numerical Study of Transition to Supersonic Flows in the Edge Plasma

RAJIV GOSWAMI, JEAN-FRANCOIS ARTAUD, FREDERIC IMBEAUX, and PREDHIMAN KAW

**Physics of Plasmas, 21, 072510, 2014**

Visco-elastic Fluid Simulations of Coherent Structures in Strongly Coupled Dusty Plasma Medium

VIKRAM SINGH DHARODI, SANAT KUMAR TIWARI, and AMITA DAS

**Physics of Plasmas, 21, 073705, 2014**

(IPR/RR-659/2014)

Kolmogorov Flow in Two Dimensional Strongly Coupled Dusty Plasma

AKANKSHA GUPTA, R. GANESH, and ASHWIN JOY

**Physics of Plasmas, 21, 073707, 2014**

(IPR/RR-656/2014)



Statistical Charge Distribution over Dust Particles in a non-Maxwellian Lorentzian Plasma

S. K. MISHRA, and SHIKHA MISRA  
**Physics of Plasmas, 21, 073706, 2014**

Improvement of Charged Particles Transport across a Transverse Magnetic Filter Field by Electrostatic Trapping of Magnetized Electrons

B. K. DAS, P. HAZARIKA, M. CHAKRABORTY, and M. BANDYOPADHYAY  
**Physics of Plasmas, 21, 072118, 2014**

Dynamics of a Confined Dusty Fluid in a Sheared Ion Flow

MODHUCHANDRA LAISHRAM, DEVENDRA SHARMA, and PREDHIMAN K. KAW  
**Physics of Plasmas, 21, 073703, 2014**  
**(IPR/RR-657/2014)**

Observation of Transient Electric Fields in Particle-In-Cell Simulation of Capacitively Coupled Discharges

S. SHARMA, S. K. MISHRA and PREDHIMAN K. KAW  
**Physics of Plasmas, 21, 073511, 2014**  
**(IPR/RR-655/2014)**

Preliminary Corrosion Studies of P-91 in Flowing Lead-Lithium with and Without Magnetic Field for Indian Lead-Lithium Ceramic Breeder Test Blanket Module

ATCHUTUNI SARADA SREE, KAMBLE TANAJI, CHAKRABORTY POULAMI, R.K. FOTEDAR, E. RAJENDRA KUMAR, A.K. SURI, E. PLATACIS, A. ZIKS, I. BUCENIEKS, A. POZNIJAKS, and A. SHISKO  
**Nuclear Fusion, 54, 083029, 2014**

Bacterial Cells Enhance Laser Driven Ion Acceleration

MALAY DALUI, M. KUNDU, T. MADHU TRIVIKRAM, R. RAJEEV, KRISHANU RAY and M. KRISHNAMURTHY  
**Scientific Reports, 4, 6002, 2014**

Implementation of an F-Statistic All-Sky Search for Continuous Gravitational Waves in Virgo VSR1 Data

J. AASI (LIGO Scientific Collaboration, Virgo Collaboration, and IPN Collaboration)  
**Classical and Quantum Gravity, 31, 165014, 2014**

Inter-code comparison benchmark between DINA and TSC for ITER disruption modelling

S. MIYAMOTO, A. ISAYAMA, I. BANDYOPADHYAY, S.C. JARDIN, R.R. KHAYRUTDINOV, V.E. LUKASH, Y. KUSAMA and M. SUGIHARA

**Nuclear Fusion, 54, 083002, 2014**

Global Gyrokinetic Stability of Collisionless Microtearing Modes in Large Aspect Ratio Tokamaks

ADITYA K. SWAMY, R. GANESH, J. CHOWDHURY, S. BRUNNER, J. VACLAVIK and L. VILLARD  
**Physics of Plasmas, 21, 082513, 2014**  
**(IPR/RR-637/2014)**

Propagation Dynamics of Laterally Colliding Plasma Plumes in Laser-Blow-Off of Thin Film

BHUPESH KUMAR, R. K. SINGH, SUDIP SENGUPTA, P. K. KAW and AJAI KUMAR  
**Physics of Plasmas, 21, 083510, 2014**  
**(IPR/RR-668/2014)**

Exact Propagating Nonlinear Singular Disturbances in Strongly Coupled Dusty Plasmas

AMITA DAS, SANAT KUMAR TIWARI, PREDHIMAN KAW, and ABHIJIT SEN  
**Physics of Plasmas, 21, 083701, 2014**  
**(IPR/RR-528/2011)**

Sheath Formation under Collisional Conditions in Presence of Dust

R. MOULICK and K. S. GOSWAMI  
**Physics of Plasmas, 21, 083702, 2014**

Studies on Hydrogen Plasma and Dust Charging in Low-Pressure Filament Discharge

B. KAKATI, D. KALITA, S. S. KAUSIK, M. BANDYOPADHYAY, and B. K. SAIKIA  
**Physics of Plasmas, 21, 083704, 2014**

Potential Formation in a Collisionless Plasma Produced in an Open Magnetic Field in Presence of Volume Negative Ion Source

ANANYA PHUKAN, K. S. GOSWAMI, and P. J. BHUYAN  
**Physics of Plasmas, 21, 084504, 2014**

A Novel Approach for Mitigating Disruptions using Biased Electrode in Aditya Tokamak

PRAVESH DHYANI, J. GHOSH, P.K. CHATTOPADHYAY, R.L. TANNA, D. RAJU, S. JOISA, ASIM KUMAR CHATTOPADHYAY, DEBJYOTI BASU, N. RAMAIYA, S. KUMAR, K. SATHYANARAYANA, S.B. BHATT, P.K. ATREY, C.N. GUPTA, C.V.S. RAO, RATNESHWAR JHA, Y.C. SAXENA and R. PAL  
**Nuclear Fusion, 54, 083023, 2014**



Damage Studies on Tungsten Due to Helium Ion Irradiation  
N.J. DUTTA, N. BUZARBARUAH, and S.R. MOHANTY  
**Journal of Nuclear Materials**, **452**, 51-56, 2014

Thermal Behavior of SST-1 Vacuum Vessel and Plasma Facing Components during Baking  
ZIAUDDIN KHAN, YUVAKIRAN PARAVASTU and SUBRATA PRADHAN  
**Procedia Materials Science**, **6**, 216-228, 2014

Temperature Instability in High-Tc Superconducting Wire Exposed to Thermal Disturbance  
ZIAUDDIN KHANA, SUBRATA PRADHAN and IRFAN AHMED  
**Procedia Materials Science**, **6**, 249-255, 2014

Magnetic properties of Co doped MgTiO<sub>3</sub> ceramics  
SANTHOSH KUMAR THATIKONDA, PALLABI GOGOI, BHAGABAN KISAN, ALAGARSAMY PERUMAL, PRAMOD SHARMA, and PAMU DOBBIDI  
**Physica B: Condensed Matter**, **448**, 330-332, 2014

A Signature for Turbulence Driven Magnetic Islands  
O. AGULLO, M. MURAGLIA, A. POYE, S. BENKADDA, M. YAGI, X. GARBET and A. SEN  
**Physics of Plasmas**, **21**, 092303, 2014

Lunar Photoelectron Sheath and Levitation of Dust  
M. S. SODHA and S. K. MISHRA  
**Physics of Plasmas**, **21**, 093704, 2014

High Power CW Testing of 3.7-GHz Klystron for SST1 LHCD System  
PROMOD KUMAR SHARMA, KIRAN K. AMBULKAR, SHEFALI DALAKOTI, NATARAJABOOBATHI RAJANBABU, PRAMOD R. PARMAR, CHETAN G. VIRANI, and ARVINKUMAR L. THAKUR  
**IEEE Transactions on Plasma Science**, **42**, 2298-2308, 2014

Opacity and Atomic Analysis of Double Pulse Laser Ablated Li Plasma  
V SIVAKUMARAN, H C JOSHI and AJAI KUMAR  
**Physica Scripta**, **89**, 095604, 2014  
(IPR/RR-576/2012)

First All-Sky Search for Continuous Gravitational Waves from Unknown Sources in Binary Systems

J. AASI *et al* (LIGO Scientific Collaboration, Virgo Collaboration, and IPN Collaboration)  
**Physical Review D**, **90**, 062010, 2014

Cordierite Based Glass-Ceramic Glazed Floor Tiles by Microwave Processing  
SUMANA GHOSH, KALYAN SUNDAR PAL, ASHIS KUMAR MANDAL, NILORMI BISWAS, MANJIMA BHATTACHARYA, and PAYEL BANDYOPADHYAY  
**Materials Characterization**, **95**, 192-200, 2014

Surface Activation of Polyester Fabric using Ammonia Dielectric Barrier Discharge and Improvement in Colour Depth  
HEMEN DAVE, LALITA LEDWANI, NISHA CHANDWANI, BHAKTI DESAI, and S K NEMA  
**Indian Journal of Fibre & Textile Research**, **39**, 274-281, 2014

Design, Development and Fabrication of Indigenous 30 kA NbTi CICC for Fusion Relevant Superconducting Magnet  
MAHESH GHATE, PIYUSH RAJ, ARUN SINGH, SUBRATA PRADHAN, M.M. HUSSAIN, and K.K. ABDULLA  
**Cryogenics**, **63**, 166-173, 2014

Double Imaging with an Intensified Visible Fast Camera to Visualize the Fine Structure of Turbulent Coherent Plasma Structures (Blobs) in TJ-II  
E DE LA CAL, P SEMWAL, A MARTIN AGUILERA, B VAN MILLIGEN, J L DE PABLOS, Z KHAN and C HIDALGO  
**Plasma Physics and Controlled Fusion**, **56**, 105003, 2014

On the Existence of Vapor-Liquid Phase Transition in Dusty Plasmas  
M. KUNDU, K. AVINASH, A. SEN and R. GANESH  
**Physics of Plasmas**, **21**, 103705, 2014

Time-Delay Effects on the Aging Transition in a Population of Coupled Oscillators  
BHUMIKA THAKUR, DEVENDRA SHARMA, and ABHINAV SEN  
**Physical Review E - Statistical, Nonlinear, and Soft Matter Physics**, **90**, 042904, 2014  
(IPR/RR-686/2014)

Coherent Structures in Ion Temperature Gradient Turbulence-Zonal Flow  
RAMESWAR SINGH, R. SINGH, P. KAW, O. D. GURCAN and P. H. DIAMOND

**Physics of Plasmas, 21, 102306, 2014**

Dynamics of Compressional Mach Cones in a Strongly Coupled Complex Plasma

P. BANDYOPADHYAY, R. DEY, SANGEETA KADYAN and ABHIJIT SEN

**Physics of Plasmas, 21, 103707, 2014  
(IPR/RR-692/2014)**

A Set-Up for a Biased Electrode Experiment in ADITYA Tokamak

PRAVESH DHYANI, JOYDEEP GHOSH, K SATHYANARAYANA, V E PRAVEENLAL, PRAMILA GAUTAM, MINSHA SHAH, R L TANNA, PINTU KUMAR, C CHAVDA, N C PATEL, V PANCHAL, C N GUPTA, K A JADEJA, S B BHATT, S KUMAR, D RAJU, P K ATREY, S JOISA, P K CHATTOPADHYAY and Y C SAXENA

**Measurement Science and Technology, 25, 105903, 2014**

ITER Components Cooling: Satisfying the Distinct Needs of Systems and Components

STEVEN JAMES PLOYHAR, BABULAL GOPALAPILLAI, LILIANA CRISTINA TEODOROS, GIOVANNI DELL'ORCO, AJITH KUMAR, DINESH GUPTA, NIRAV PATEL, and MAHESH ASHOK JADHAV

**Fusion Engineering and Design, 89, 1975-1978, 2014**

Status of Indian LLCB TBM Program and R&D Activities

R. BHATTACHARYAY, and INDIAN TBM TEAM

**Fusion Engineering and Design, 89, 1107-1112, 2014**

Design and Development of Hydrogen Isotope Sensor in Liquid PbLi

AMIT SIRCAR, SANJEEV KUMAR SHARMA, RUDREKSH B. PATEL, and P.A. RAYJADA

**Fusion Engineering and Design, 89, 1223-1226, 2014**

Progress in Engineering Design of Indian LLCB TBM Set for Testing in ITER

PARITOSH CHAUDHURI, S. RANJITHKUMAR, DEEPAK SHARMA, CHANDAN DANANI, H.L. SWAMI, R. BHATTACHARYA, ANITA PATEL, E. RAJENDRA KUMAR, and K.N. VYAS

**Fusion Engineering and Design, 89, 1362-1369, 2014**

Current Status of Technology Development for Fabrication of Indian Test Blanket Module (TBM) of ITER

T. JAYAKUMAR, and E. RAJENDRA KUMAR

**Fusion Engineering and Design, 89, 1562-1567, 2014**

Design of ITER Vacuum Vessel In-Wall Shielding

X. WANG, K. IOKI, M. MORIMOTO, C.H. CHOI, Y. UTIN, C. SBORCHIA, O. TAILHARDAT, B. MILLE, A. TERASAWA, Y. GRIBOV, V. BARABASH, E. POLUNOVSKIY, S. DANI, H. PATHAK, J. RAVAL, S. LIU, M. LU, and S. DU

**Fusion Engineering and Design, 89, 1814-1819, 2014**

Influence of Phase Transformation on Thermo-mechanical Analysis of Modified 9Cr-1Mo Steel

M. ZUBAIRUDDIN, S.K. ALBERT, V. CHAUDHARI, and V.K. SURI

**Procedia Materials Science, 5, 832-840, 2014**

A Welding Simulation of Dissimilar Materials SS304 and Copper

SURESH AKELLA, VEMANABOINA HARINADH, YAGGADI KRISHNA, and RAMESH KUMAR BUDDU

**Procedia Materials Science, 5, 2440-2449, 2014**

Welding Process Simulation Model for Temperature and Residual Stress Analysis

HARINADH VEMANABOINA, SURESH AKELLA, and RAMESH KUMAR BUDDU

**Procedia Materials Science, 6, 1539-1546, 2014**

X-Ray Absorption Spectroscopy Characterization of Iron-Oxide Nanoparticles Synthesized by High Temperature Plasma Processing

C. BALASUBRAMANIAN, B. JOSEPH, P. GUPTA, N.L. SAINI, S. MUKHERJEE, D. DI GIOACCHINO, and A. MARCELLI

**Journal of Electron Spectroscopy and Related Phenomena, 196, 125-129, 2014**

Influence of Magnetic Field on Laser-Produced Barium Plasmas: Spectral and Dynamic Behaviour of Neutral and Ionic Species

MAKARAJU SRINIVASA RAJU, R. K. SINGH, PRAMOD GOPINATH and AJAI KUMAR

**Journal of Applied Physics, 116, 153301, 2014**

Effect of Argon Addition on Plasma Parameters and Dust Charging in Hydrogen Plasma

B. KAKATI, S. S. KAUSIK, M. BANDYOPADHYAY, B. K. SAIKIA and Y. C. SAXENA

**Journal of Applied Physics, 116, 163302, 2014**

Adiabatic Electron Response and Solitary Wave Generation by Trapped Particle Nonlinearity in a Hydrogen Plasma

DEBRAJ MANDAL and DEVENDRA SHARMA  
**Physics of Plasmas, 21, 102107, 2014**  
**(IPR/RR-670/2014)**

Plasma Diagnostics at Aditya Tokamak by Two Views Visible Light Tomography  
 MAYANK GOSWAMI, PRABHAT MUNSHI, ANUPAM SAXENA, MANOJ KUMAR, and AJAI KUMAR  
**Fusion Engineering and Design, 89, 2659-2665, 2014**

Mechanical Properties of 9Cr-1W Reduced Activation Ferritic Martensitic Steel Weldment Prepared by Electron Beam Welding Process  
 C.R. DAS, S.K. ALBERT, SHIJU SAM, P. MASTANAIAH, G.M.S.K. CHAITANYA, A.K. BHADURI, T. JAYAKUMAR, C.V.S. MURTHY, and E. RAJENDRA KUMAR  
**Fusion Engineering and Design, 89, 2672-2678, 2014**

Fusion yield measurements on JET and their calibration  
 D.B. SYME, S. POPOVICHEV, S. CONROY, I. LENGAR, L. SNOJ, C. SOWDEN, L. GIACOMELLI, G. HERMON, P. ALLAN, P. MACHETA, D. PLUMMER, J. STEPHENS, P. BATISTONI, R. PROKOPOWICZ, S. JEDNOROG, M.R. ABHANGI, R. MAKWANA, and JET EFDA CONTRIBUTORS  
**Fusion Engineering and Design, 89, 2766-2775, 2014**

Multimessenger Search for Sources of Gravitational Waves and High-Energy Neutrinos: Initial results for LIGO-Virgo and IceCube  
 M.G. AARTSEN *et al* (*LIGO Scientific Collaboration, Virgo Collaboration, and IPN Collaboration*) **Physical Review D, 90, 102002, 2014**

Measurement of Spatial and Temporal Behavior of H $\alpha$  Emission from Aditya Tokamak using a Diagnostic Based on a Photomultiplier Tube Array  
 M. B. CHOWDHURI, J. GHOSH, R. MANCHANDA, AJAY KUMAR, S. BANERJEE, N. RAMAIIYA, NIRAL VIRANI, ANIRUDDH MALI, A. AMARDAS, PINTU KUMAR, R. L. TANNA, C. N. GUPTA, S. B. BHATT, and P. K. CHATTOPADHYAY  
**Review of Scientific Instruments, 85, 11E411, 2014**

Silicon Drift Detector Based X-Ray Spectroscopy Diagnostic System for the Study of Non-Thermal Electrons at Aditya Tokamak  
 S. PUROHIT, Y. S. JOISA, J. V. RAVAL, J. GHOSH, R. TANNA, B. K. SHUKLA, and S. B. BHATT  
**Review of Scientific Instruments, 85, 11E419, 2014**

Analytical Estimate of Phase Mixing Time of Longitudinal Akhiezer-Polovin Waves  
 ARGHYA MUKHERJEE and SUDIP SENGUPTA  
**Physics of Plasmas, 21, 112104, 2014**  
**(IPR/RR-681/2014)**

Characteristics of the Positive Ion Source at Reduced Gas Feed  
 S. K. SHARMA, P. BHARATHI, V. PRAHLAD, P. J. PATEL, B. CHOKSI, M. R. JANA, L. K. BANSAL, K. QURESHI, C. B. SUMOD, V. VADHER, D. THAKKAR, L. N. GUPTA, S. RAMBABU, S. PARMAR, N. CONTRACTOR, A. K. SAHU, B. PANDYA, B. SRIDHAR, S. PANDYA and U. K. BARUAH  
**Review of Scientific Instruments, 85, 113504, 2014**

Numerical Studies on Helium Cooled Divertor Finger Mock Up with Sectorial Extended Surfaces  
 SANDEEP RIMZA, KAMALAKANTA SATPATHY, SAMIR KHIRWADKAR, and KARUPANNA VELUSAMY  
**Fusion Engineering and Design, 89, 2647-2658, 2014**  
**(IPR/RR-627/2013)**

Statistical Modelling of Discharge Behavior of Atmospheric Pressure Dielectric Barrier Discharge  
 W. H. TAY, S. S. KAUSIK, C. S. WONG, S. L. YAP, and S. V. MUNIANDY  
**Physics of Plasmas, 21, 113502, 2014**

Excitation Function of  $^{56}\text{Fe}(n, \alpha)^{53}\text{Cr}$  Reaction from Threshold to 20 MeV for Fusion Applications  
 P. M. PRAJAPATI, BHAWNA PANDEY, C. V. S. RAO, S. JAKHAR, T. K. BASU, B. K. NAYAK, S. V. SURYANARAYANA, and A. SAXENA  
**Fusion Science and Technology, 66, 426-431, 2014**  
**(IPR/RR-691/2014)**

Incorporation of Lithium Lead Eutectic as a Working Fluid in RELAP5 and Preliminary Safety Assessment of LLCS  
 A.K. TRIVEDI, K.T. SANDEEP, C. ALLISON, A. KHANNA, V. CHAUDHARI, E.R. KUMAR, and P. MUNSHI  
**Fusion Engineering and Design, 89, 2956-2963, 2014**

Bridge Joint Fabrication and Validation for SST-1 PF Coil Winding Pack  
 UPENDRA PRASAD, A.N. SHARMA, D. PATEL, K. DOSHI, P. VARMORA, Y. KHRISTI, and S. PRADHAN  
**Fusion Engineering and Design, 89, 3078-3082, 2014**



Mechanical Properties and Microstructural Investigations of TIG Welded 40 mm and 60 mm Thick SS 316L Samples for Fusion Reactor Vacuum Vessel Applications

RAMESH KUMAR BUDDU, N. CHAUHAN, and P.M. RAOLE

**Fusion Engineering and Design, 89, 3149-3158, 2014 (IPR/RR-660/2014)**

Cyclic Softening as a Parameter for Prediction of Remnant Creep Rupture Life of a Indian Reduced Activation Ferritic-Martensitic (IN-RAFM) Steel Subjected to Fatigue Exposures

ARITRA SARKAR, V.D. VIJAYANAND, VANI SHANKAR, P. PARAMESWARAN, R. SANDHYA, K. LAHA, M.D. MATHEW, T. JAYAKUMAR, and E. RAJENDRAKUMAR

**Fusion Engineering and Design, 89, 3159-3163, 2014**

Thermal-Hydraulic and Thermo-Mechanical Design of Plasma Facing Components for SST-1 Tokamak

PARITOSH CHAUDHURI, S.K.S. PARASHAR, P. SANTRA, and D. CHENNA REDDY

**International Journal of Thermal Sciences, 86, 299-306, 2014**

Compatibility Study of Plasma Grown Alumina Coating with Pb-17Li under Static Conditions

NIRAV I. JAMNAPARA, A. SARADA SREE, E. RAJENDRA KUMAR, S. MUKHERJEE, and A.S. KHANNA

**Journal of Nuclear Materials, 455, 612-617, 2014**

An Absolute Method for Determination of Misalignment of an Immersion Ultrasonic Transducer

M.M. NARAYANAN, NARENDER SINGH, ANISH KUMAR, C. BABU RAO, and T. JAYAKUMAR

**Ultrasonics, 54, 2081-2089, 2014**

A Reconsideration of the Noise Equivalent Power and the Data Analysis Procedure for the Infrared Imaging Video Bolometers

SHWETANG N. PANDYA, BYRON J. PETERSON, MASAHIRO KOBAYASHI, SANTOSH P. PANDYA, KIYOFUMI MUKAI and RYUICHI SANO

**Review of Scientific Instruments, 85, 123501, 2014**

Delta Ferrite in the Weld Metal of Reduced Activation Ferritic Martensitic Steel

SHIJU SAM, C.R. DAS, V. RAMASUBBU, S.K. ALBERT, A.K. BHADURI, T. JAYAKUMAR, and E. RAJENDRA KUMAR

**Journal of Nuclear Materials, 455, 343-348, 2014**

Improved Upper Limits on the Stochastic Gravitational-Wave Background from 2009-2010 LIGO and Virgo Data

J. AASI, and A. KUMAR, et al.

**Physical Review Letters, 113, 231101, 2014**

Laser Heated Emissive Probes Design and Development under National Fusion Program and Potential Measurement

MEHTA PAYAL, ARUN SARMA, and JOYDEEP GHOSH

**Chinese Physics Letters, 31, 125201, 2014**

Interpreting the Behavior of a Quarter-Wave Transmission Line Resonator in a Magnetized Plasma

G. S. GOGNA, S. K. KARKARI, and M. M. TURNER

**Physics of Plasmas, 21, 123510, 2014**

Morpho-Sedimentary Characteristics of the Quaternary Material Fan and Associated River Terraces, Jalpaiguri, India: Implications for Climatic Controls

RIMPAL KAR, TAPAN CHAKRABORTY, CHANDAN CHAKRABORTY, PARTHSARATHI GHOSH, ANIL K. TYAGI, and ASHOK K. SINGHVI

**Geomorphology, 227, 137-152, 2014**

Development of a Prototype Hybrid DC Circuit Breaker for Superconducting Magnets Quench Protection

ROY, S. , KANABAR, D. , DODIYA, C. , and PRADHAN, S.

**IEEE Transactions on Applied Superconductivity, 24, 6845332, 2014**

Experimental and Finite Element Analysis of Residual Stress and Distortion in GTA Welding of Modified 9Cr-1Mo Steel

MOHAMMED ZUBAIRUDDIN, SHAJU K. ALBERT, S. MAHADEVAN, M. VASUDEVAN, VILAS CHAUDHARI, and V. K. SURI

**Journal of Mechanical Science and Technology, 28, 5095-5105, 2014**

Microwave Synthesis and Mechanical Characterization of Functionally Graded Material for Applications in Fusion Devices

CHARU LATA DUBE, YASHASHRI PATIL, SHAILESH KANPARA, SAMIR S KHIRWADKAR and SUBHASH C KASHYAP

**Bulletin of Material Science, 37, 1607-1611, 2014**

Electron-Emission-Induced Cooling of Boundary Region in Fusion Devices

SANJAY K. MISHRA, K. AVINASH, and PREDHIMAN KAW

**Journal of Plasma Physics, 80, 863, 2014**

42-GHz/500-kW Electron Cyclotron Resonance Heating System on Tokamak SST-1

BRAJ KISHORE SHUKLA, PARESH J. PATEL, JATIN PATEL, RAJAN BABU, HARSHIDA PATEL, PRAGNESH DHORAJIA, PRASHANT SINGH, CHEERAMVEETIL B. SUMOD, DIPAL P. THAKKAR, LAXMI NARAYAN GUPTA, UJJWAL K. BARUA, RATNESHWAR JHA, DHIRAJ BORA, MIKHAIL SHMELEV, VLADIMIR IRKHIN, MIKHAIL KHOZIN, VLADIMIR BELOUSOV, ELENA SOLUYANOVA, EVGENY TAI, ZAKHAR GASAINIEV, and GREGORY DENISOV

**IEEE Transactions on Plasma Science, 43, 485-489, 2015**

Quench Characterization and Thermo Hydraulic Analysis of SST-1 TF Magnet Busbar

A.N. SHARMA, S. PRADHAN, J.L. DUCHATEAU, Y. KHRISTI, U. PRASAD, K. DOSHI, P. VARMORA, V.L. TANNA, D. PATEL, and A. PANCHAL

**Fusion Engineering and Design, 90, 67-72, 2015**

A Critique of Recent Semi-Classical Spin-Half Quantum Plasma Theories

G. S. KRISHNASWAMI, R. NITYANANDA, A. SEN and A. THYAGARAJA

**Contributions to Plasma Physics, 55, 3-11, 2015**

Development of Excel Based Static Simulator for Various Test Phases of ITER Prototype Cryoline

SHAH NITIN, CHOUKEKAR KETAN, JADON MOHIT, SARKAR BISWANATH

**Indian Journal of Cryogenics, 39, 128-133, 2014**

Acoustic Emission Studies on Weld Bead Defects in Nuclear Grade SS 316L Materials

S. V. RANGANAYAKULU, J. SHIVA RAJU, A. KUCHED-LUDU, and B. RAMESH KUMAR

**Open Journal of Acoustics, 4, 115-130, 2014**

Structural Details of Laser Treated SS 304 and SS 316L(N) Plates

PARDHU YELLA, VENKATESWARLU PINNOJU, KOTESWARARAO V. RAJULAPATI, P. PREM KIRAN, RAMESH KUMAR BUDDU, P.M. RAOLE, K. BHANU SANKARA RAO

**Procedia Engineering, 86, 27-33, 2014**

Structural Modification of Stainless Steel Surface Using Pulsed Lasers

P. VENKATESHWARLU, PARDHU YELLA, RAMESH KUMAR BUDDU, K. BHANU SANKARA RAO, RAOLE P.M., KOTESWARARAO V. RAJULAPATI, P. PREM KIRAN

**Technology Letters, 1, 5-8, 2014**

Growth of Industrial Scale Nanocrystalline TiN Film using Cylindrical Magnetron System

R. RANE, M. RANJAN, P.A. RAYJADA, and S. MUKHERJEE

**International Journal of Thin Films Science and Technology, 3, 89, 2014**

The Study of Electromagnetic Cusp Solitons

DEEPA VERMA, AMITA DAS, PREDHIMAN KAW, and SANAT KUMAR TIWARI

**Physics of Plasmas, 22, 013101, 2015 (IPR/RR-693/2014)**

Wall Charging of a Helicon Antenna Wrapped Plasma Filled Dielectric Tube

KSHITISH K. BARADA, P. K. CHATTOPADHYAY, J. GHOSH, Y. C. SAXENA, and D. BORA

**Physics of Plasmas, 22, 013507, 2015 (IPR/RR-677/2014)**

Design of a Linear Neutron Source

N. BUZARBARUAH, N.J. DUTTA, J.K. BHARDWAZ, and S.R. MOHANTY

**Fusion Engineering and Design, 90, 97-104, 2015**

Searching for Stochastic Gravitational Waves Using Data from the Two Colocated LIGO Hanford Detectors

J. AASI *et al* (*LIGO Scientific Collaboration, Virgo Collaboration, and IPN Collaboration*)

**Physical Review D, 91, 022003, January 2015**

Effect of Deuterium Ion Beam Irradiation onto the Mirror-Like Pulsed Laser Deposited Thin Films of Rhodium

A.T.T. MOSTAKO, ALIKA KHARE, C.V.S. RAO, SUDHIRSINH VALA, R.J. MAKWANA, and T.K. BASU

**Nuclear Instruments and Methods in Physics Research, Section B: Beam Interactions with Materials and Atoms, 342, 150-157, 2015**

Narrow-band Search of Continuous Gravitational-Wave Signals from Crab and Vela Pulsars in Virgo Vsr4 Data

J. AASI *et al* (*LIGO Scientific Collaboration, Virgo Col-*



*laboration, and IPN Collaboration)*

**Physical Review D - Particles, Fields, Gravitation and Cosmology, 91, 022004, 2015**

Synchronization between Two Coupled Direct Current Glow Discharge Plasma Sources

NEERAJ CHAUBEY, S. MUKHERJEE, A. N. SEKAR IYENGAR, and A. SEN

**Physics of Plasmas, 22, 022312, 2015**  
**(IPR/RR-712/2015)**

Turbulence in Strongly Coupled Dusty Plasmas using Generalized Hydrodynamic Description

SANAT KUMAR TIWARI, VIKRAM SINGH DHARODI, AMITA DAS, BHAVESH G. PATEL, and PREDHIMAN KAW

**Physics of Plasmas, 22, 023710, 2015**

Role of Neutral Gas in Scrape-Off Layer Tokamak Plasma

N. BISAI, R. JHA, and P. K. KAW

**Physics of Plasmas, 22, 022517, 2015**  
**(IPR/RR-709/2015)**

Electron Density Modification in Ionospheric E Layer by Inserting Fine Dust Particles

SHIKHA MISRA, and S. K. MISHRA

**Physics of Plasmas, 22, 023706, 2015**

Statistical Mechanics of Dust Charging in a Multi-Ion Plasma with Negative and Positive Ionic Species

S. K. MISHRA, and SHIKHA MISRA

**Physics of Plasmas, 22, 023705, 2015**

Particle-in-cell Simulation of Large Amplitude Ion-Acoustic Solitons

SARVESHWAR SHARMA, SUDIP SENGUPTA, and ABHIJIT SEN

**Physics of Plasmas, 22, 022115, 2015**  
**(IPR/RR-697/2014)**

Resolving an Anomaly in Electron Temperature Measurement using Double and Triple Langmuir Probes

SOUMEN GHOSH, K K BARADA, P K CHATTOPADHYAY, J GHOSH, and D BORA

**Plasma Sources Science and Technology, 24, 015017, 2015**  
**(IPR/RR-669/2014)**

Molecular Dynamics Simulation of Helium Atom Diffusion in Iron-Chromium Bicrystal Grain

A. ABHISHEK, M. WARRIER, R. GANESH

**Transactions of the Indian Institute of Metals, February 2015**

**(IPR/RR-654/2014)**

Silver Nanoparticles on GaSb Nanodots: a LSPR-boosted Binary Platform for Broadband Light Harvesting and SERS  
MUKUL BHATNAGAR, MUKESH RANJAN, and SUBROTO MUKHERJEE

**Journal of Nanoparticle Research, 17, 1-13, 2015**

Chimera States in a Population of Identical Oscillators under Planar Cross-Coupling

C R HENS, A MISHRA, P K ROY, A SEN, and S K DANA

**Pramana - Journal of Physics, 84, 229-235, 2015**

Photophysical Behavior and Fluorescence Quenching by Halides of Quinidine Dication: Steady State and Time Resolved Study

NEERAJ KUMAR JOSHI, NEERAJ TEWARI, PRIYANKA ARORA, RANJANA RAUTELA, SANJAY PANT, HEM CHANDRA JOSHI

**Journal of Luminescence, 158, 412-416, 2015**

Microscopic Origin of Shear Relaxation in a Model Viscoelastic Liquid

J. ASHWIN, and ABHIJIT SEN

**Physical Review Letters, 114, 055002, 2015**

A Simple Experimental Method to Determine Magnetic Field Topology in Toroidal Plasma Devices

SHEKAR G. THATIPAMULA, UMESH K. SHUKLA, R. GANESH, Y. C. SAXENA, and D. RAJU

**Review of Scientific Instruments, 86, 033504, 2015**  
**(IPR/RR-701/2014)**

Stabilization of Rayleigh-Taylor Instability in a Non-Newtonian Incompressible Complex Plasma

S. GARAI, D. BANERJEE, M. S. JANAKI, and N. CHAKRABARTI

**Physics of Plasmas, 22, 033702, 2015**

Dynamical Programming based Turbulence Velocimetry for Fast Visible Imaging of Tokamak Plasma

SANTANU BANERJEE, H. ZUSHI, N. NISHINO, K. MISHRA, T. ONCHI, A. KUZMIN, Y. NAGASHIMA, K. HANADA, K. NAKAMURA, H. IDEI, M. HASEGAWA, and A. FUJISAWA

**Review of Scientific Instruments, 86, 033505, 2015**  
**(IPR/RR-694/2014)**



Plasma Density Estimation of a Fusion Grade ICP Source through Electrical Parameters of the RF Generator Circuit  
M. BANDYOPADHYAY, DASS SUDHIR, and A. CHAKRABORTY

**Nuclear Fusion, 55, 033017, 2015**

Formation of Collisional Sheath in Electronegative Plasma with Two Species of Positive Ions

R. MOULICK, and K. S. GOSWAMI

**Physics of Plasmas, 22, 033510, 2015**

Molecular Dynamics Simulations of Soliton-Like Structures in a Dusty Plasma Medium

SANAT KUMAR TIWARI, AMITA DAS, ABHIJIT SEN, and PREDHIMAN KAW

**Physics of Plasmas, 22, 033706, 2015**

Coaxial Propagation of Laguerre-Gaussian (LG) and Gaussian Beams in a Plasma

SHIKHA MISRA, SANJAY K. MISHRA, and P. BRIJESH

**Laser and Particle Beams, 33, 123-133, 2015**

Decomposition Modes of Austenite in 9Cr-W-V-Ta Reduced Activation Ferritic-Martensitic Steels

RAVIKIRANA, R. MYTHILI, S. RAJU, S. SAROJA, T. JAYAKUMAR, and E. RAJENDRA KUMAR

**Materials Science and Technology, 31, 448-459, 2015**

Comparative Analysis of Insulating Properties of Plasma and Thermally Grown Alumina Films on Electrospark Aluminide Coated 9Cr Steels

N.I. JAMNAPARA, STEFANO FRANGINI, J. ALPHONSA, N.L. CHAUHAN, and S. MUKHERJEE

**Surface and Coatings Technology, 266, 146-150, 2015**

Magnetic, Thermal and Transport Behavior in Single Crystalline  $RCu_2Ge_2$  ( $R=La, Ce, Pr$  and  $Sm$ ) Compounds

H. MENDPARA, DEVANG A. JOSHI, A.K. NIGAM, and A. THAMIZHAVEL

**Journal of Magnetism and Magnetic Materials, 377, 325-333, 2015**

Directed Search for Gravitational Waves from Scorpius X-1 with Initial LIGO Data

J. AASI, and A. KUMAR et al.

**Physical Review D - Particles, Fields, Gravitation and Cosmology, 91, 062008, 2015**

Design Optimization of Heat Exchanger Used in Cryopump

Cooling Circuit for a Typical Fusion Machine: A Parametric Study

SHAH NITIN, SARKAR BISWANATH, NAIK HEMANT

**Indian Journal of Cryogenics, 40, 112-117, 2015**

Development in Design of Test Infrastructure for ITER Prototype Cryoline Test

CHOUKEKAR KETAN, BHATTACHARYA RITENDRA, SHAH NITIN, SRINIVASA MURALIDHARA, KAPOOR HIMANSHU, PATEL PRATIK, KUMAR UDAY AND

SARKAR BISWANATH

**Indian Journal of Cryogenics, 40, 140-146, 2015**

Seismic and Random Vibration Analysis of Internal Cryogenic Lines of Cold Valve Box

HIMANSHU KAPOOR, JOTIRMOY DAS, UDAY KUMAR, HITENSINH VAGHELA, RITENDRA BHATTACHARYA, and BISWANATH SARKAR

**Indian Journal of Cryogenics, 40, 35-41, 2015**

Localized Surface Plasmon Resonance Anisotropy in Template Aligned Silver Nanoparticles: A Case of Biaxial Metal Optics

MUKESH RANJAN, MUKUL BHATNAGAR, and SUBROTO MUKHERJEE

**Journal of Applied Physics, 117, 103106, 2015**

### E.1.2 Conference Papers

Integrated liquid nitrogen distribution network for the cooling of SST-1 80K thermal shields system

G.L.N. SRIKANTH, K. PATEL, R. PANCHAL, P. SHAH, V.L. TANNA, S. PRADHAN, and M.K. GUPTA

**13th International Institute of Refrigeration Conference on Cryogenics, CRYOGENICS 2014, Prague, Czech Republic, 277-281, 2014**

Integration of LHCD System with SST1 Machine and its High Power RF Performance in Vacuum

P. K. SHARMA, K. K. AMBULKAR, S. DALAKOTI, P. R. PARMAR, C. G. VIRANI, and A. L. THAKUR

**AIP Conference Proceedings, 1580, 470, 2014**

Plasma Rotation and NTM Onset Driven by Central EC Deposition in TCV Tokamak

S. NOWAK, E. LAZZARO, O. SAUTER, G. CANAL, B. DUVAL, L. FEDERSPIEL, A. N. KARPUSHOV, D. KIM,

D. RAJU, H. REIMERDERS, J. ROSSEL, D. TESTA, D. WAGNER, and TCV TEAM

**AIP Conference Proceedings, 1580, 502, 2014**

Studies of Adsorption Characteristics of Activated Carbons Down to 4.5 K for the Development of Cryosorption Pumps for Fusion Systems

S. KASTHURIRENGAN, U. BEHERA, G. A. VIVEK, V. KRISHNAMOORTHY, R. GANGRADEY, S. S. UDGATA and V. S. TRIPATI

*AIP Conference Proceedings, 1573, 1206, 2014*

Operational and Troubleshooting Experiences in the SST-1 Cryogenic System

G. MAHESURIA, P. PANCHAL, R. PANCHAL, R. PATEL, D. SONARA, N. C. GUPTA, G. L. N. SRIKANTH, D. CHRISTIAN, A. GARG, N. BAIRAGI, K. PATEL, P. SHAH, H. NIMAVAT, R. SHARMA, J. C. PATEL, J. TANK, V. L. TANNA, and S. PRADHAN

*AIP Conference Proceedings, 1573, 1645, 2014*

Characterization of Cesium Vapor Delivery System for Negative Ion Sources

BANSAL, G., PANDYA, K., SONI, J., GAHLAUT, A., BANDYOPADHYAY, M., and CHAKRABORTY, A.

*ICOPS/BEAMS 2014 - 41st IEEE International Conference on Plasma Science and the 20th International Conference on High-Power Particle Beams, 7012431, 2015*

Breathing Mode of Dust Cloud in a Cogenerated Dusty Plasma

BOSE, M.; Sarkar, S.; Atul, J.K. ; Mondal, M.; and Mukherjee, S.

*ICOPS/BEAMS 2014 - 41st IEEE International Conference on Plasma Science and the 20th International Conference on High-Power Particle Beams, 7012428, 2015*

Large Volume Penning Plasma Discharge Source: An Efficient Light Emitting Source for the Visible and VUV Radiations Simultaneously

LAL VYAS, G.; PRAKASH, R.; PAL, U.N. ; MANCHANDA, R. ; and HALDER, N.

*ICOPS/BEAMS 2014 - 41st IEEE International Conference on Plasma Science and the 20th International Conference on High-Power Particle Beams, 7012288, 2015*

42GHz ECRH Assisted Plasma Breakdown in Tokamak SST-1

B. K. SHUKLA, S. PRADHAN, PARESH PATEL, RAJAN BABU, JATIN PATEL, HARSHIDA PATEL, PRAGNESH DHORAJIA, V. TANNA, P K ATREY, R MANCHANDA, MANOJ GUPTA, SHANKAR JOISA, C N GUPTA, RAJU DANIAL, PRASHANT SINGH, R. JHA, D. BORA and

SST-1 TEAM

*EPJ Web of Conferences, 87, 02008, 2015*

Status of the Design of the ITER ECE Diagnostic

G. TAYLOR, M. E. AUSTIN, J. H. BENO, S. DANANI, R. F. ELLIS, R. FEDER, J. L. HESLER, A. E. HUBBARD, D. W. JOHNSON, R. KUMAR, S. KUMAR, V. KUMAR, A. OUROUA, H. K. B. PANDYA, P. E. PHILLIPS, C. ROMAN, W. L. ROWAN, V. UDINTSEV, G. VAYAKIS, and M. WALSH

*EPJ Web of Conferences, 87, 03002, 2015*

New Approach to ECE Measurements Based on Hilbert-Transform Spectral Analysis

HITESH KUMAR B. PANDYA, and YURIY DIVIN

*EPJ Web of Conferences, 87, 03003, 2015*

Computational Studies on ECE Spectrum for ITER, in the Presence of a Small Fraction of Non-Thermals and Radial Resolution Evolution for Oblique View

P.V. SUBHASH, YASHIKA GHAI, HITESH K. PANDYA, AMIT K. SINGH, A. M. BEGAM, and P. VASU

*EPJ Web of Conferences, 87, 03004, 2015*

Engineering Aspects of Design and Integration of ECE Diagnostic in ITER

V.S. UDINTSEV, G. TAYLOR, H.K.B. PANDYA, M.E. AUSTIN, N. CASAL, R. CATALIN, M. CLOUGH, B. CUQUEL, M. DAPENA, J.-M. DREVON, R. FEDER, J.P. FRICONNEAU, T. GIACOMIN, J. GUIRAO, M.A. HENDERSON, S. HUGHES, S. IGLESIAS, D. JOHNSON, SIDDHART KUMAR, VINA KUMAR, B. LEVESY, D. LOESSER, M. MESSINEO, C. PENOT, M. PORTALES, J.W. OOSTERBEEK, A. SIRINELLI, C. VACAS, G. VAYAKIS, and M.J. WALSH

*EPJ Web of Conferences, 87, 03006, 2015*

Gigabit Ethernet based Image Acquisition System for IR camera

H. MANDLIYA, A. TANDON, J. SHAH, and R. RAJPAL  
*6th International Conference on Computational Intelligence and Communication Networks (CICN 2014), 453-457, 2015*

Investigation of Optical Response of Ag Nanodots and Nanoparticle Arrays

BHATNAGAR, M. RANJAN, S. MUKHERJEE  
*International Conference on Fibre Optics and Photonics, IIT, Kharagpur, India, 13-16 December 2014*

Role of Trapped Electrons on Global Gyrokinetic Linear Stability of Collisionless Microtearing Modes

ADITYA K SWAMY, R GANESH, J CHOWDHURY, S BRUNNER, J VACLAVIK and L VILLARD

*Journal of Physics: Conference Series*, 561, 012017, 2014

Inertia Driven Radial Breathing and Nonlinear Relaxation in Cylindrically Confined Pure Electron Plasma

M. Sengupta and R. Ganesh

*AIP Conference Proceedings*, 1668, 020005, 2015

### E.1.3 Book Chapters

Enhanced Absorption of Sub-Cycle Laser Pulses in Cluster

M. KUNDU, and P. K. KAW

**Advances in Laser Physics and Technology**, Edited by Man Mohan, Anil Kumar, Aranya B. Bhattacharjee and Anil K. Razdan, Cambridge University Press, India, 2015.

ISBN: 978-93-84-84463-41-0 (Book Chapter)

Book Title : **Plasma Technologies for Textiles and Apparel**,

Wood-Head Publishing India Pvt. Ltd., New Delhi; ISBN: 978-93-80308-55-5

Basics of Plasma and its industrial applications in Textiles

R.Rane, M.Ranjan, S. Mukherjee

Nanotitania synthesis and its integration in textiles using plasma technology

C. Balasubramanian

Atmospheric Pressure Plasma Processing of Textiles at FCIPT

S. K. Nema, P. B. Jhala

Plasma Textile Technology status, Techno-Economics, Limitations and Industrial usage Potential

P. B. Jhala, S. K. Nema

### E.1.4 Books Edited

A book titled "**Plasma Technologies for Textile and Apparel**" published by Woodhead publishing India, was released on 10th Dec. 2014 by Shri Saurabh Patel, Hon'ble Minister of Finance, Energy and Petrochemicals, Govt. of Gujarat, during the Inaugural session of INTEXCON 2014; at Gandhinagar, Gujarat. The book was edited by **Dr. S. K. Nema** of IPR and **Prof. P. B. Jhala**, Research Advisor, NID.

## E.2 Internal Technical Reports

Installation and Testing of 220V, 1500A DC Power Supply at IPR

DEVEN KANABAR, SWATI ROY and SUBRATA PRADHAN

IPR/TR-278/2014 (APRIL 2014)

Simulation Studies for the Deformation in Metal Gaskets for UHV Application

SHISHIR PUROHIT and B RAMESH KUMAR

IPR/TR-279/2014 (ARRIL 2014)

Development, Testing and Integration with DAC of 14 Volt, 450 Ampere DC Regulated Filament Power Supply for 200 kW, 91.2 MHz CWRP Amplifier

BHAVESH R KADIA, KIRIT PARMAR, YSS SRINIVAS, H. M. JADAV, AZAD MAKWANA, S.V. KULKARNI & ICRH GROUP

IPR/TR-280/2014 (MAY 2014)

Design & Simulation of Low Loss Circular Corrugated Waveguide for High Power 42 GHz, 200 kW Gyrotron

JINAL A. MISTRY, SHAIK EJAZUDDIN, S. V. KULKARNI and ICRH GROUP

IPR/TR-281/2014 (MAY 2014)

Design & Simulation of Double Disc Sapphire RF Window for High Power 42 GHz, 200 kW Gyrotron

JINAL A. MISTRY, SHAIK EJAZUDDIN, S. V. KULKARNI and ICRH GROUP

IPR/TR-282/2014 (MAY 2014)

Development of Plasma Aluminizing Process for Inconel (IN 718) Alloys

N. I. JAMNAPARA, S. MUKHERJEE, S. VENUGOPAL, R. S. RANE, N. L. CHAUHAN, S. B. GUPTA, N. VAGHELA, K. KALARIA, B. K. PATEL, C. CHAVDA, N. C. PATEL

IPR/TR-283/2014 (MAY 2014)

Design & Simulation of RF Coaxial Vacuum Window for ICRH System for Tokamak Aditya

SANKET CHAUDHARY, EJAZUDDIN SHAIK, ATUL VARIA, S.V. KULKARNI and ICRH GROUP

IPR/TR-284/2014 (MAY 2014)

Design & Analysis of RF Switch and Impedance Matching in T-Junction Transmission Line

SANKET V CHAUDHARY, ATUL VARIA, EJAZUDDIN SHAIK, S V KULKARNI and ICRH GROUP

IPR/TR-285/2014 (MAY 2014)

Design & Analysis of RF Window for 10GHz Realistic Magnetron Coupling





SANKET V CHAUDHARY, EJAZUDDIN SHAIK, S V KULKARNI and ICRH GROUP  
IPR/TR-286/2014 (MAY 2014)

Design & Simulation of Single Disc Diamond Window for High Power 42 GHz, 200 kW Gyrotron  
JINAL A. MISTRY, SHAIK EJAZUDDIN, S.V. KULKARNI & ICRH GROUP  
IPR/TR-287/2014 (MAY 2014)

Conditioning of SST-1 Tokamak Vacuum Vessel by Baking and Glow Discharge Cleaning  
ZIAUDDIN KHAN, SIJU GEORGE, PRATIBHA SEMWAL, KALPESH R. DHANANI, FIROZKHAN S. PATHAN, YUVAKIRAN PARAVASTU, D. C. RAVAL, GATTU R. BABU, M.S. KHAN and SUBRATA PRADHAN  
IPR/TR-288/2014 (MAY 2014)

Development of Atmospheric Pressure Plasma System to Improve Adhesion between Fabric and Coating  
R. RANE, A.VAID, N.CHANDWANI, S.MUKHERJEE, M.PARIKH, S.BASU, and S.K.NEMA  
IPR/TR-289/2014 (MAY 2014)

Theoretical Calculation and Analysis Modelling for the Effective Thermal Conductivity of Lithium Metatitanate Pebble Bed  
MAULIK PANCHAL, A. SHRIVASTAVA, P. CHAUDHURI, and E. RAJENDRAKUMAR  
IPR/TR-290/2014 (MAY 2014)

Material Surface Characterization Facilities at FCIPT  
ALPHONSA JOSEPH, PURVI KIKANI, NIRAV JAMNAPARA, MUKESH RANJAN, C. BALASUBRAMANIAN and S. MUKHERJEE  
IPR/TR-291/2014 (JUNE 2014)

DAC Controlled Voltage Variable RF Attenuator for Generating RF Pulses of Different Shapes and Amplitudes for ICRH System  
MANOJ SINGH, HM JADAV, RAMESH JOSHI, SUNIL KUMAR, SRINIVAS YSS, SV KULKARNI, and RF-ICRH GROUP  
IPR/TR-292/2014 (JUNE 2014)

GPIB Based Instrumentation and Control System for ADITYA Thomson Scattering Diagnostic  
KIRAN PATEL, MAULIK SUTHAR, VISHNU CHAUDHARI, JINTO THOMAS, NEHA SINGH, VISHAL PILLAI, and AJAI KUMAR  
IPR/TR-293/2014 (JUNE 2014)

Data Acquisition, Control and Operation of Diagnostics and Vacuum Interface Sections of ICRH-RF systems on SST-1  
H. M. JADAV, MANOJ SINGH, RAMESH JOSHI, ATUL VARIA, A. GAYATRI, S.V. KULKARNI and ICRH-RF GROUP  
IPR/TR-294/2014 (JULY 2014)

Up gradation of Fiber Optic based Analog Signal Link for ECRH system of SST  
HARSHIDA PATEL, POONAM SINGH, SWETA SIDDHUPURA, B. K. SHUKLA, JATIN PATEL, N. RAJAN BABU, PRAGNESH DHORAJIYA and CHETAN VIRANI  
IPR/TR-295/2014 (JULY 2014)

Experimental and Monte-Carlo Absolute Efficiency Calibration of HPGe gamma-ray Spectrometer for Application in Neutron Activation Analysis  
SHAILJA TIWARI, S. JAKHAR, M.ABHANGI, R. MAKWANA, V. CHAUDHARI, C.V.S. RAO, T. K. BASU  
IPR/TR-296/2014 (JULY 2014)

Developments toward Remote Metrology for SST1 Vacuum Vessel using Close Range Digital Photogrammetry  
GATTU RAMESH BABU, ZIAUDDIN KHAN and SUBRATA PRADHAN  
IPR/TR-297/2014 (JULY 2014)

Investigations of the Inspection Possibilities of Curved Cu-W Monoblock Assembly Using Ultrasonic Phased Array  
KEDAR BHOPE, MAYUR MEHTA, and S.S.KHIRWADKAR  
IPR/TR-298/2014 (AUGUST 2014)

Report on Ultrasonic Inspection and Microhardness testing on High Heat Flux tested Cu-W Mono-blocks  
KEDAR BHOPE, MAYUR MEHTA, CHARU LATA DUBE, M.S.KHAN, and S.S.KHIRWADKAR  
IPR/TR-299/2014 (AUGUST 2014)

480 A DC Power Supply Validation with High TC Based Superconducting Load  
UPENDRA PRASAD, PIYUSH RAJ, A.PANCHAL, A.BANO, P.VARMORA, D.KANWAR and S.PRADHAN  
IPR/TR-300/2014 (AUGUST 2014)

Pb-Li Loop for testing Liquid Metal Diagnostics  
S. SAHU, R. BHATTACHARYAY, A. DEOGHAR, A. PRAJAPATI, S. GUPTA, and S. VERMA  
IPR/TR-301/2014 (AUGUST 2014)

Development of Micro-controller based EMCCD Camera  
VISHNU CHAUDHARI, and AJAI KUMAR  
IPR/TR-302/2014 (AUGUST 2014)

Study on Plasma Gasification of Petroleum Waste in to Syn-Gas  
A. SANGHARIYAT, P. V. MURUGAN, B.K. PATEL, C. PATIL, V. CHAUHAN, V. JAIN, S. MUKHERJEE, and S.K. NEMA  
IPR/TR-303/2014 (SEPTEMBER 2014)

Control and Data Acquisition System for Characterization of Microwave Components for ECE Diagnostics in ITER- India Lab  
JIGNESH PATEL, PRAVEENA KUMARI, VISMAYSINH RAULJI, SUMAN DANANI, and RACHANA RAJPAL  
IPR/TR-304/2014 (SEPTEMBER 2014)

Detection and Mitigation of Electro-magnetic Interference Noise to Enhance Detection Sensitivity of SST-1 Thomson Scattering System  
VISHNU CHAUDHARI, KIRAN PATEL, JINTO THOMAS and AJAI KUMAR  
IPR/TR-305/2014 (SEPTEMBER 2014)

Steady State CFX and Structural Analysis of the ITER-like Shield Blanket Module First Wall Mock Up  
RITESH KUMAR SRIVASTAVA and PARITOSH CHAUDHURI  
IPR/TR-306/2014 (SEPTEMBER 2014)

Design, Fabrication and Testing of Variable di/dt, (10MA/sec max) Current Pulse Generation System for SST-1 Rogowski Calibration  
Y.S.S. SRINIVAS, M.V. GOPALA KRISHNA, BHAVESH KADIA, SAMEER KUMAR, E.V. PRAVEEN LAL, D. RAJU, S.V. KULKARNI, and R. JHA  
IPR/TR-307/2014 (SEPTEMBER 2014)

Slowing and Stopping of Wave in Dispersive Metamaterial Loaded Helical Guide  
DUSHYANT K. SHARMA, and SURYA K. PATHAK  
IPR/TR-308/2014 (SEPTEMBER 2014)

Commissioning of Integrated Power Supply (15kV, 28A and three auxiliary supplies) for Testing of 200kW stage CWRF Amplifiers  
BHAVESH R KADIA, Y.S.S. SRINIVAS, KIRIT M PARMAR, H. M. JADAV, RAMESH JOSHI, SUNIL KUMAR,

S. V. KULKARNI, and ICRH GROUP  
IPR/TR-309/2014 (SEPTEMBER 2014)

Measurement of Threshold Voltage during Vacuum Arc on Satellite Solar Panel Coupons in Laboratory  
R. JOSHI and S. B. GUPTA  
IPR/TR-310/2014 (OCTOBER 2014)

Development of an ESD Detection and Characterization Facility for Space like LEO and GEO Environment  
S. B. GUPTA, K. R. KALARIA, N. P. VAGHELA, R. S. JOSHI, S. MUKHERJEE, S. E. PUTHANVEETIL, M. SHANKARAN and R.S. EKKUNDI  
IPR/TR-311/2014 (OCTOBER 2014)

Behavior of Arc Current Waveform on Satellite Solar Panels and its Dependence on Arc Location, Dissipated Charge and Irradiation Time  
RASHMI S. JOSHI, and SURYAKANT B. GUPTA  
IPR/TR-312/2014 (OCTOBER 2014)

Calorimetric Pulse Power Measurement Technique for High Power Gyrotrons  
HARSHIDA PATEL, B. K. SHUKLA, PRAGNESH DHORAJIYA, RAJAN BABU, JATIN PATEL, MIKHAIL SHMELEV, YURY BELOV, R. JHA, and D. BORA  
IPR/TR-313/2014 (OCTOBER 2014)

An update of spacecraft charging research in India: Spacecraft Plasma Interaction eXperiments - SPIX-II  
SURYAKANT B. GUPTA, S. MUKHERJEE, KEENA R. KALARIA, NARESH P. VAGHELA, RASHMI S. JOSHI, SURESH E. PUTHANVEETIL, M. SANKARAN AND RANGANATH S. EKKUNDI  
IPR/TR-314/2014 (NOVEMBER 2014)

Amendment of Signal Conditioning System for Neutral Beam Injector of SST-1  
KARISHMA QURESHI, P. J. PATEL, L. K. BANSAL, P. BHARATHI, S. L. PARMAR, L. N. GUPTA, VIJAY VADHER, DIPAL THAKKAR, C. B. SUMOD, B. CHOKSI, S. SHARMA, M. R. JANA, V. PRAHLAD and U. K. BARUAH  
IPR/TR-315/2014 (NOVEMBER 2014)

Experimental Study for Water and Ferritic Steel Shielding Properties with 14MeV Neutron Irradiation of Double Wall Shell  
S. JAKHAR, B. RAMESH KUMAR, R. MAKWANA, M. ABHANGI, C. V. S. RAO and T. K. BASU  
IPR/TR-316/2014 (NOVEMBER 2014)



Coolant Calorimetry Set-Up Developed for the High Heat Flux Test Facility at IPR

YASHASHRI PATIL, S. S. KHIRWADKAR, SUNIL BELSARE, RAJAMANNAR SWAMY, SUDHIR TRIPATHI, and KEDAR BOPE

IPR/TR-317/2014 (NOVEMBER 2014)

Magnetic Field Analyses, Fabrication and Validation of Mono-Filamentary MgB<sub>2</sub> based Racetrack Coil

ANANYA KUNDU, PIYUSH RAJ, UPENDRA PRASAD, ARUN PANCHAL, ANEES BANO, PANKAJ VARMORA, SUBRAT KUMAR DAS, NITISH KUMAR, DHAVAL BHAVSAR, and SUBRATA PRADHAN

IPR/TR-318/2015 (JANUARY 2015)

Development of Tangential View Far Infrared Interferometer for SST- 1

RAJWINDER KAUR, ASHA ADHIYA, PABITRA KUMAR MISHRA, SWADESH PATNAIK, and SHRISHAIL PADASALAGI

IPR/TR-319/2015 (JANUARY 2015)

Testing of Process Sensors for High-Temperature & High-Pressure Liquid-Metal Applications

A. SARASWAT, S. SAHU, A.K. PRAJAPATI, S. GUPTA, T. S. RAO, R. P. BHATTACHARYAY, and P. DAS

IPR/TR-320/2015 (JANUARY 2015)

LSPR Anisotropy in Template Aligned Silver Nanoparticles: A Case of Biaxial Metal Optics

MUKESH RANJAN, MUKUL BHATNAGAR, and S. MUKHERJEE

IPR/TR-321/2015 (JANUARY 2015)

Interface of LHE Level Monitor as an Interlock with Quench Detection System for the Gyrotron Magnet System

MONI BANAUDHA, YOHAN KHRISTI, PIYUSH RAJ, and SUBRATA PRADHAN

IPR/TR-322/2015 (JANUARY 2015)

Silver Nanoparticle on GaSb Nanodot: A LSPR Boosted Binary Platform for Broadband Light Harvesting and SERS

MUKUL BHATNAGAR, MUKESH RANJAN, and SUBROTO MUKHERJEE

IPR/TR-323/2015 (JANUARY 2015)

Experimental Validation of Negative Refraction of Novel Single-Sided FF-Shaped Metamaterial

DUSHYANT KUMAR SHARMA, JJU BUCH, and SURYA

KUMAR PATHAK

IPR/TR-324/2015 (FEBRUARY 2015)

Design and Development of a 200kV, 15mA High Voltage DC Test Generator

AMAL S, URMIL M THAKER, KUMAR SAURABH, and UJJWAL K BARUAH

IPR/TR-325/2015 (FEBRUARY 2015)

Design, Implementation and Optimization of Gigabit Ethernet Network for I&C Interfacing at High Heat Flux Test Facility

R. SUGANDHI, T. PATEL, R.ROSHAN, I. ANTWALA, and S. KHIRWADKAR

IPR/TR-326/2015 (FEBRUARY 2015)

Frequency Sweep Linearization of Scanned Frequency Reflectometer System for Plasma Density Profile Measurement

N.Y. JOSHI, J.J.U. BUCH, and S.K. PATHAK

IPR/TR-327/2015 (FEBRUARY 2015)

Determination of Heat Transfer Effectiveness of Thermal Insulating Materials for High Temperature Process Pipes

ADITYA KUMAR VERMA, S. VERMA, A. SARASWAT, J. CHAUHAN, E. R. KUMAR, and K.N.VYAS

IPR/TR-328/2015 (MARCH 2015)

Nuclear Performance Analyses of Indian LLCB TBM Set for ITER: Conceptual Design

H L SWAMI, A K SHAW, and C DANANI

IPR/TR-329/2015 (MARCH 2015)

Design and Development of Extremely Low Ripple and Highly Stabilised DC Power Supply Rated for 30V, 300A

AZADSINH MAKWANA, CHIRAGKUMAR DODIYA, BHADRESH PARGHI, and SUBRATA PRADHAN

IPR/TR-330/2015 (MARCH 2015)

State Feedback Control of Chopper Fed DC Motor using Linear Quadratic Regulator Method in MATLAB-SIMULINK

AMIT K SRIVASTAVA, ARNAB DAS GUPTA, NITYA SRIVASTAVA, and ZIAUDDIN KHAN

IPR/TR-331/2015 (MARCH 2015)

Development of PXI based Data Acquisition and Control (DAC) system for RF-ICRH system

MANOJ SINGH, HM JADAV, RAMESH JOSHI, YSS SRINIVAS, SUNIL KUMAR, SV KULKARNI, and RF-ICRH GROUP

IPR/TR-332/2015 (MARCH 2015)



Design and Development of PLC based DAC for 45.6 MHz, 100kW ICRH system using EPICS and MODBUS/TCP  
RAMESH JOSHI, H M JADAV, YSS SRINIVAS, SUNIL KUMAR, and S.V. KULKARNI  
IPR/TR-333/2015 (MARCH 2015)

Experimental Test Set up To Evaluate Spring Back in Superconducting CICC's at Room Temperature  
ARUN PANCHAL, MAHESH GHATE, DHAVALBHAVSAR, and SUBRATA PRADHAN  
IPR/TR-334/2015 (MARCH 2015)

Application of Articulated Absolute Co-ordinate Measuring Machine for Quality Control in Fabrication of Radial Plates  
DHAVAL BHAVSAR, MAHESH GHATE, ARUN PANCHAL, and SUBRATA PRADHAN  
IPR/TR-335/2015 (MARCH 2015)

Development of Hardware for Liquid Flow Measurement with LabVIEW  
AMIT KUMAR SRIVASTAVA, SURYAKANT B. GUPTA, and DIPAK ADHYARU  
IPR/TR-336/2015 (MARCH 2015)

Design, Fabrication and Development of Lab Scale Vacuum Heat Treatment Furnace  
DHAVAL BHAVSAR, PIYUSH RAJ, MAHESH GHATE, CHIRAG DODIYA, and SUBRATA PRADHAN  
IPR/TR-337/2015 (MARCH 2015)

### E.3 Conference Presentations

*13th International Institute of Refrigeration Conference on Cryogenics, CRYOGENICS 2014; Prague, Czech Republic, 7-11 April 2014*

Integrated liquid nitrogen distribution network for the cooling of SST-1 80K thermal shields system  
G.L.N. Srikanth, K. Patel, R. Panchal, P. Shah, V.L. Tanna, S. Pradhan, M.K. Gupta

*International Institute of Welding - International Welding Congress (IC 2014), New Delhi, 9-11 April 2014*

A Transient Finite Element Simulation for the Thermo-Mechanical Study of Lip Seal Laser Weld Joints  
Ashish Yadav, Chandramoulli Rotti, Mukesh Jindal, Jaydeep Joshi, and Arun Chakraborty

Inspection of welded aero material of Aluminium HE-15  
S V Ranganayakulu, A. Kucheludu, B. Veerabhadraiah, B Ramesh Kumar

*26th Meeting of the ITPA Pedestal and Edge Physics Topical group, Prague, Czech Republic, 15-17 April 2014*

Numerical Investigation of Pedestal Structure in the Presence of External Sources and Flows  
Nirmal Bisai

*18th Joint Workshop on Electron Cyclotron Emission and Electron Cyclotron Resonance Heating, Nara, Japan, 22-25 April 2014*

New approach to ECE measurements based on Hilbert-transform spectral analysis  
Hitesh Kumar B. Pandya and Yuriy Divin

Status of the design of the ITER ECE diagnostic  
G. Taylor, M. E. Austin, J. H. Beno, T. W. Crowe, S. Danani, R. F. Ellis, R. Feder, A. E. Hubbard, D. W. Johnson, R. Kumar, S. Kumar, A. Ouroua, H. K. B. Pandya, P. E. Phillips, C. Roman, W. L. Rowan, V. Ushintsev, G. Vayakis, and M. Walsh

Engineering aspects of design and integration of microwave diagnostics in ITER  
V.S. Ushintsev, G. Vayakis, M.J. Walsh, J.-M. Drevon, T. Giacomini, J.W. Oosterbeek, M. Portalès, A. Sirinelli, M.E. Austin, R. Feder, M.A. Henderson, D. Johnson, H. Pandya, P. Sanchez, D. Shelukhin, G. Taylor, V. Vershkov

Computational studies on ECE spectrum for ITER, in the presence on a small fraction of non-thermals and radial resolution evolution for oblique view  
P.V. Subhash, Yashika Ghai, Hitesh Kumar B. Pandya, Mehraj B, P. Vasu

*41st IEEE International Conference on Plasma Science, and 20th International Conference on High-Power Particle Beams (ICOPS/BEAMS 2014), Marriott Wardman Park, Washington DC, 25-29 May 2014*

Characterization of Cesium Vapor Delivery System for Negative Ion Sources  
G. Bansal, K. Pandya, J. Soni, A. Gahlaut, M. Bandyopadhyay, A. Chakraborty

*20th Topical Conference on High Temperature Plasma Diagnostics (HTPD-2014), Atlanta, Georgia, U.S.A., 1-5 June 2014*



Measurement of Spatial and Temporal Behavior of Ha Emission from Aditya Tokamak using a PMT Array based Diagnostic

M. B. Chowdhuri, J. Ghosh, R. Manchanda, Ajay Kumar, S. Banerjee, N. Ramaiya, Niral Virani, Aniruddh Mali, A. Amardas, Pintu Kumar, R. L. Tanna, C. N. Gupta, S. B. Bhatt, P. K. Chattopadhyay and Aditya Team

**12th Kudowa Summer School Towards Fusion Energy, Kudowa Zdroj, Poland, 9-13 June 2014**

R&D on Divertor Plasma Facing Components at IPR  
Yashashri Patil

**13th Spacecraft Charging Technology Conference (SCTC), Pasadena, USA, 23-27 June 2014**

An update of spacecraft charging research in India: Spacecraft Plasma Interaction eXperiments SPIX -II

Suryakant B. Gupta, S. Mukherjee, Keena R. Kalaria, Naresh P. Vaghela, Rashmi S. Joshi, Suresh E. Puthanveetil, M. Sankaran and Ranganath S. Ekkundi

Behavior of arc current waveform on satellite solar panel and its dependence on arc location, dissipated charge and irradiation time

Rashmi S. Joshi and Suryakant B. Gupta

**PSSI-Plasma Scholars Colloquium 2014, VIT University, Chennai, Tamilnadu, India, 3-5 July 2014**

Phase Mixing of Longitudinal Akhiezer - Polovin Wave: An Analytical Treatment

Arghya Mukherjee and Sudip Sengupta

Spectroscopic Study of Filament Discharge Helium Plasma  
Vara Prasad K, and Joydeep Ghosh

Will Trapped Electrons Make Microtearing Mode Unstable in Large Aspect Ratio Tokamaks?

Aditya Krishna Swamy

Compensation of overestimated electron temperature by the triple Langmuir probe

Soumen Ghosh and Prabal Kumar Chattopadhyay

Investigation of frequency entrainment between two unidirectionally coupled DC glow discharge plasmas with varying harmonic dynamics

Neeraj Chaubey, S. Mukherjee, A. N. Sekar Iyengar, and A. Sen

**25th International Cryogenic Engineering Conference - International Cryogenic Materials Conference 2014 (ICEC25-ICMC 2014), University of Twente in The Netherlands, 7-11 July 2014**

Control methodology and test modes during the qualification test of ITER Cold Circulator

R. Bhattacharya, B. Sarkar, H. Vaghela, P. Patel, Srinivasa M., H.-S. Chang, T. Isono, Katsumi Kawano, Minoru Sato, and M. Chalifour

Investigation of thermal equilibrium around an accidental event and impact on possibly enclosed surrounding environment

Sarkar Biswanath, Shah Nitin, Choukekar Ketan, Kapoor Himanshu, Kumar Uday, Das Jotirmoy, Bhattacharaya Riten-dra, Vaghela Hitensinh and Muralidhara Srinivasa

Acceptance plan and performance measurement methodology for the ITER cryoline system

S. Badgular, M. Bonneton, N. Shah, M. Chalifour, H.-S. Chang, E. Fauve, A. Forgeas, N. Navion-Maillot and B. Sarkar

**67th IIW Annual Assembly and International Conference, Seol, South Korea, 13-18 July 2014**

Studies on the Microstructure and Toughness of Simulated Heat Affected Zone in a Modified 9Cr-1Mo Steel

H.C. Dey, Alpesh Patel, A.K. Bhaduri, Shiju Sam, S.K. Albert, G.G. Roy

**Hindi Seminar, Official Language Implementation Committee, IPR, 27 August 2014**

EPICS based prototype software for ICRH DAC  
Ramesh Joshi

Setup & Backup Thunderbird for IPR email system  
Shailendra Trivedi

Leave Rules of Staff Members  
Sunil Misal

Multi-Layer Insulation: A Cryogenic Superinsulation  
Nitin Bairagi

Road Safety - An Emerging Challenge  
Devendra Modi

Computer simulations of Runaway Electrons in Tokamaks for production, energy dynamics and detection  
Santosh P. Pandya

Open Access Web Resources  
S. Shravan Kumar

Role of Magnet in SST-1  
Uendra Prasad, S. Pradhan and SST-1 Magnet Division

***Joint Varenna - Lausanne International Workshop on Theory of Fusion Plasmas, Villa Monastero, Varenna, Italy, 1-5 September 2014***

Role of Trapped Electrons in Microtearing Modes  
Aditya K Swamy, R Ganesh, J Chowdhury, S Brunner, J Vackovic, L Villard

***5th Euro-Asian Pulse Power Conference (EAPPC), Kumamoto, Japan, 8-12 September 2014***

Study of Impedance Impact in Converter System with Multi-secondary Transformers for High Voltage Power Supply  
D. Parmar, N. P. Singh, B. Raval, D. Upadhyay, A. Thakar, A. Patel, H. Dhola, R. Dave, S. Gajjar, V. Gupta, N. Goswami, K. Mehta, and U. Baruah

***5th AASPP Workshop on Asian Nuclear Reaction Database Development, Bhabha Atomic Research Center, Mumbai, 22-24 September 2014***

Discussed ongoing activities of nuclear data of Fusion Neutronics Laboratory (FNL) IPR, with the experts during the workshop  
Bhawna Pandey

***International Symposium on Discharges and Electrical Insulation in Vacuum (ISDEIV-2014), Nehru Centre, Worli, Mumbai, India, 28 September-03 October 2014***

Electrical Design Analysis and Breakdown Voltage Test Aspects of Indigenously Developed Electrical Breaks at Cryo Temperatures  
Rajiv Sharma, V.L. Tanna, A. Amardas, S. Pradhan and S. Chandramouli

Comparative Study of Glow Discharge Wall Conditioning using H<sub>2</sub> and Ar-H<sub>2</sub> Gas Mixture of ADITYA Tokamak Vacuum Vessel

K. A. Jadeja, K. M. Patel, R.L. Tanna, Deepak Sangwan, K. S. Acharya, N.D. Patel, M. K. Raval, Pintu Kumar, S. B. Bhatt, J. Ghosh and Aditya Team

Design of Vacuum Vessel for Aditya Upgrade Tokamak  
S. B. Bhatt, K. A. Jadeja, V. R. Prajapati, Kulav Rathod, K. M. Patel, J Ghosh and Aditya Team

Engineering aspects of Microwave Diagnostic at ITER  
K. M. Patel, V. S. Udintsev, G. Vayakis, T. Giacomini, D. Johnson, Ph. Maquet, H. K. B. Pandya, C. Penot, M. Portales, M. Proust, J. W. Oosterbeek, V. Vershkov, M.J. Walsh

Development of an ESD Detection and Characterization Facility for Space like LEO and GEO Environment  
S. B. Gupta, K. R. Kalaria, N. P. Vaghela, R. S. Joshi, S. Mukherjee, S. E. Puthanveetil, M. Sankaran and R.S. Ekkkundi

Measurement of Threshold Voltage during Vacuum Arc on Satellite Solar Panel Coupons in Laboratory  
R. Joshi and S. B. Gupta

Mitigation Techniques for arcing on space solar panels –results from ISRO  
Suresh Puthanveetil, M. Sankaran and S. B. Gupta

Solar panel space plasma interaction studies in India  
M. Sankaran, E.P. Suresh and S. B. Gupta

***28th Symposium on Fusion Technology (SOFT 2014), San Sebastian, Spain, 29 September- 03 October 2014***

Development of Laser Beam Welding for the Lip Seal Configuration  
Ashish Yadav, Jaydeep Joshi, Dhananjay Kumar Singh, Harshad Natu, Chandramouli Rotti, Mainak Bandyopadhyay, and Arun Chakraborty

New design aspects of cooling scheme for SST-1 plasma facing components  
Yuvakiran Paravastu, Ziauddin Khan and Subrata Pradhan

Status of R&D activity for ITER ICRF Power Source System  
Aparajita Mukherjee, Rajesh Trivedi, Raghuraj Singh, Ku-





mar Rajnish, Harsha Machchhar, P. Ajesh, Gajendra Suthar, Dipal Soni, Manoj Patel, Kartik Mohan, JVS Hari, Rohit Anand, Sriprakash Verma, Rohit Agarwal, Akhil Jha, Fabienne Kazarian, Bertrand Beaumont

Design of Vacuum Vessel for Indian Test Facility (INTF) for 100keV Neutral Beams

Jaydeep Joshi, Ashish Yadav, R. Gangadharan, Rambilas Prasad, Shino Ulahannan, Chandramouli Rotti, Mainak Bandyopadhyay, and Arun Chakraborty

Maturity assessment of ITER diagnostics Plant Instrumentation and control design

Stefan Simrock, Lana Abadie, Robin Barnsley, Bertrand Baurvir, Luciano Bertalot, Petri Makijarvi, Mikyung Park, Roger Reichle, Denis Stepanov, George Vayakis, Anders Wallander, Michael Walsh, Axel Winter, Izuru Yonekawa, Zhao Li, Tsuyoshi Yamamoto, Sanjeev Varshney, Jihyun Choi, Ekaterina Mironov, Andre Neto, Bill DeVan, Prabhakant Patil, Manojkumar Annigeri, Dariusz Makowski, Klemen Zagar, Vincent Martin

ITER Ion Cyclotron H&CD System Integration in ITER

Bertrand Beaumont, Bharat Arambhadiya, Thibault Gasmann, Fabienne Kazarian, Philippe Lamalle, Dharmendra Rathi, Roberta Sartori, Lionel Meunier, Aparajita Mukherjee, Rajesh Trivedi, Narinder P. Singh, David Rasmussen, Mike McCarthy, Tania Alonzo Montemayor, François Calarco, Houda Labidi

**4th International Symposium on Negative Ions, Beams and Sources (NIBS 2014), IPP Garching, Germany, 6 - 10 October 2014**

Can we estimate plasma density in ICP driver through electrical parameters in RF circuit?

M. Bandyopadhyay, Dass Sudhir and A.Chakraborty

Infrared Imaging Diagnostics for INTF Ion Beam

Dass Sudhir, M. Bandyopadhyay, R. Pandey, J. Joshi, A.Yadav, C. Rotti, M. Bhuyan, G. Bansal, J. Soni, H. Tyagi, K.Pandya and A. Chakraborty

**25th IAEA Fusion Energy Conference (IAEA-FEC-2014), St. Petersburg, Russian Federation, Russia, 13-18 October 2014**

Disruption Control Using Biased Electrode in Aditya Tokamak

Pravesh Dhyani, J. Ghosh, P.K. Chattopadhyay, R.L. Tanna, D. Raju, S. Joisa, Asim Kumar Chattopadhyay, Debjyoti Basu, N. Ramaiya, S. Kumar, K. Sathyanarayana, S.B. Bhatt, P.K. Atrey, C.N. Gupta, C.V.S. Rao, Ratneshwar Jha, Y.C. Saxena, and R. Pal

Modeling and analytic study of plasma flows on tearing mode stability

D. Chandra, A. Thyagaraja, A. Sen, C. Ham, T. C. Hender, R. J. Hastie, J. W. Connor and P. Kaw

Novel Approaches for Mitigating Plasma Disruptions and Runaway Electrons in Tokamak ADITYA

R.L. Tanna, J. Ghosh, P.K. Chattopadhyay, Pravesh Dhyani, Shishir Purohit, S. Joisa, C.V.S. Rao, V.K. Panchal, D. Raju, K.A. Jadeja, S.B. Bhatt, C.N. Gupta, Chhaya Chavda, S.V. Kulkarni, B.K. Shukla, Praveenlal E.V, Jayesh Raval, A. Amardas, P.K. Atrey, U. Dhobi, R. Manchanda, N. Ramaiya, N. Patel, M. B. Chowdhuri, S. K. Jha, R. Jha, A. Sen, Y. C. Saxena, D. Bora and the ADITYA Team

Recent ICRH-Wall Conditioning, Second Harmonic Heating and Disruption Mitigation Experiments using ICRH System in Tokamak ADITYA

S.V. Kulkarni, Sunil Kumar, Srinivas Y.S.S., Atul Varia, Ramesh Joshi, H.M. Jadav, Paihar Manoj, B.R. Kadia, Kirrit Parmar, Gayatri Ashok, R.P. Yadav, Joydeep Ghosh, Kumar Jadeja, Rakesh Tanna, S.B. Bhatt, C.N. Gupta, Kumar Ajay, Snehlata Gupta, Santanu Banerjee, Umesh Dhobi, S.K. Pathak, Praveenlal, Jayesh Raval, Shankar Joisa, R. Manchanda, Nilam Ramaiya, Niral Patel, Manoj Gupta, Santosh Pandya, Kanchan Mahavar, R. Jha, Sameer Kumar, Jinto Thomas, Ajai Kumar, Malay Chowdhuri, P.K. Chattopadhyaya, P.K. Atrey, Amita Das, P.K. Kaw and D. Bora

The First Experiments in SST-1

S. Pradhan, Z. Khan, V.L. Tanna, A.N. Sharma, K.J. Doshi, U. Prasad, H. Masand, Aveg Kumar, K.B. Patel, M.K. Bhandarkar, J.R. Dhongde, B.K. Shukla, I.A. Mansuri, A. Varadarajulu, Y.S. Khristi, P. Biswas, C.N. Gupta, D.K. Sharma, D.C. Raval, R. Srinivasan, S.P. Pandya, P.K. Atrey, P.K. Sharma, P.J. Patel, H.S. Patel, P. Santra, T.J. Parekh, K.R. Dhanani, Y. Paravastu, F.S. Pathan, P.K. Chauhan, M.S. Khan, J.K. Tank, P.N. Panchal, R.N. Panchal, R.J. Patel, S. George, P. Semwal, P. Gupta, G.I. Mahesuriya, D.P. Sonara, S.P. Jayswal, M. Sharma, J.C. Patel, P.P. Varmora, D.J. Patel, G.L.N. Srikanth, D.R. Christian, A. Garg, N. Bairagi, G.R. Babu, A.G. Panchal, M.M. Vora, A.K. Singh, R. Sharma, D. Raju, S.V. Kulkarni, M. Kumar, R. Manchanda, S. Joisa, K.

Tahiliani, S.K. Pathak, K.M. Patel, H.D. Nimavat, P.R. Shah, H.H. Chudasma, T.Y. Raval, A.L. Sharma, A. Ojha, B.R. Parghi, M. Banaudha, A.R. Makwana, M.B. Chowdhuri, N. Ramaiya, A. kumar, J.V. Raval, S. Gupta, S. Purohit, R. Kaur, A.N. Adhiya, R. Jha, S. Kumar, U.C. Nagora, V. Siju, J. Thomas, V.R. Chaudhari, K.G. Patel, K.K. Ambulkar, S. Dalakoti, C.G. Virani, P.R. Parmar, A.L. Thakur, A. Das, D. Bora and the SST-1 Team

**6th Annual ITER Annual Intellectual Property Contact Persons Meeting, ITER Organization, Cadarache, France, 20-21 October 2014**

Progress in IP activities at ITER-India  
Dilshad Sulaiman and Arun K. Chakraborty

**67th Gaseous Electronics Conference, Marriot City Center and Raleigh Convention Center, Raleigh, NC, USA, 2-7 November 2014**

Effect of mass and charge of ionic species on spatio-temporal evolution of transient electric field in CCP discharges  
Sarveshwar Sharma, S. K. Mishra, P. K. Kaw, M. M. Turner, S. K. Karkari

Observation of Transient Electric Fields in Particle-in-Cell Simulation of Capacitively Coupled Discharges  
Sarveshwar Sharma, S. K. Mishra, P. K. Kaw

Sustenance of Electro Negative Plasma in presence of Electron Temperature Gradient in Magnetized Plasma Column  
S. K. Karkari, H. Kabariya, M. Shastri, S.K. Mishra and N. Sirse

**2014 Joint ICTP-IAEA Conference on Models and Data for Plasma-Material Interaction in Fusion Devices, Trieste, Italy, 3-7 November 2014**

Helium Diffusion and Cluster Formation in Iron-Chromium Alloy: A First Principle Molecular Dynamics Study  
A. Abhishek, M. Warriar, and R. Ganesh

**27th Meeting of the ITPA Topical Group on Diagnostics, ITER Organization, France, 3-7 November 2014**

IN-DA progress on ITER ECE diagnostic system (TL & receiver)  
Hitesh Pandya, Suman Danani, Ravinder Kumar, Siddharth Kumar, Shrishail, Sajal, Vinay Kumar, and Victor Udintsev

RF Stray Radiation Protection system for ECE diagnostic (Ex-vessel)

Hitesh Pandya, Suman Danani, Ravinder Kumar, Sajal, Vinay Kumar, and Victor Udintsev

IN-DA Design Proposal for ITER ECE Radiometer (122-230 GHz)

Suman Danani, Hitesh Pandya, Ravinder Kumar, Vinay Kumar, and Victor Udintsev

Report on Passive Spectroscopy Specialist Working Group  
Sanjeev Varshney, Robin Barnsley

Progress with ITER XRCS- Survey and Edge spectrometers  
Sanjeev Varshney, Siddharth Kumar, Sapna Mishra, Kaushal Patel, Shivakant Jha, Subhash Putenvetil, Vinay Kumar, Robin Barnsley, Gunter Bertschinger, Martin O' Mullane, Phillippe Bernascolle, Shaun Huges, Stefan Simrock, Vincent Martin and Mike Walsh

IN-DA Progress on ITER XRCS prototype R&D  
Sanjeev Varshney, Sapna Mishra, Priti Kanth, Namita Yadav, Siddharth Kumar, Vinay Kumar, Robin Barnsley, Gunter Bertschinger, Martin O' Mullane

IN-DA Progress on Upper Port #09  
Siddharth Kumar, Shrishail, Shrichand, Mitul A, Sanjeev Varshney, Vinay Kumar, and Victor Udintsev

**COMSOL Conference-2014, Bangalore, India, 13-14 November 2014**

Estimation of Tungsten melt-zone size occurred during transient heat loads using COMSOL Multiphysics  
Yashashri Patil

**Diagnostics Division meeting, ITER Organization, France, 21 November 2014**

XRCS- Edge and Survey Updates  
Sanjeev Varshney, Siddharth Kumar, Sapna Mishra, Kaushal Patel, Shivakant Jha, Subhash Putenvetil, Vinay Kumar, Robin Barnsley, Gunter Bertschinger, Martin O' Mullane, Phillippe Bernascolle, Shaun Huges, Stefan Simrock, Vincent Martin and Mike Walsh

**6th Asian Thermal Spray Conference (ATSC-2014), Hyderabad, India, 24-26 November 2014**

Development of Tungsten Coating using Atmospheric Plasma



Spraying for First Wall Applications in Fusion TOKAMAK  
Shailesh Kanpara, G. Sivakumar, Kedar Bhope, S.S. Khirwadkar, S.V.Joshi,

*CPP-IPR Workshop on Linear Tokamak Divertor Simulators for Plasma Surface Interaction Studies, CPP, Sonapur, Assam, India, 24-26 November 2014*

Plasma and Fusion Science & Technology at Institute for Plasma Research  
Dhiraj Bora

A Long Journey to Ultimate Goal: CPP-IPR  
K. S. Goswami

The Thermal Plasma Processed Materials Laboratory and the Present Status of the CIMPLE-PSI  
Mayur Kakati

Dust Charging to Fusion Related Research-An Overview  
S. S. Kausik

A Description of CPP-IPR Laboratories Their Research Programs  
Editorial Team

The Many Faces of Butterflies, Species In and Around CPP-IPR Campus  
Ngangom Aomoa

Ion Irradiation of Fusion Reactor Materials to Simulate Radiation Damage by Neutron Irradiation and H/D/He Retention  
P. M. Raole

Spectroscopic Diagnostics for Characterizing the Plasmas of Linear Tokamak Divertor Simulators  
Joydeep Ghosh

An Overview on the Development of Applied Plasma Physics Experiments in Linear Device  
S. K. Karkari

Plasma Surface Interaction Studies using Infrared Thermography of Limiter in Tokamaks  
Santosh P. Pandya, Kanchan Mahavar, Shwetang N. Pandya, Hitesh Patel, Shamsuddin Shaikh, Zubin Shaikh, Kumar Ajay, J. Govindarajan, ADITYA Team, SST-1 Team

Lab Scale Development of Vacuum Brazing Technology for

Plasma Facing Components  
K. P Singh, Alpesh Patel, Kedar Bhope, Samir Khirwadkar, Sunil Belsare, Nikunj Patel, Prakash Mokaria, Mayur Mehta

Investigation of Yield Behavior and Surface Patterns after the Bombardment of Low Energy Ion on Surfaces  
M. Ranjan

MD Simulations of Temperature Dependence of Point Defect Creation Due to Low Energy Ion Bombardment in Tungsten  
P. N. Maya, S. P. Deshpande

Effects of Heavy Ion Irradiation on Surface Morphology of Polycrystalline Tungsten  
Charu Lata Dube, Pawan K. Kulariya, YashashriPatil, Mayur Mehta, Priyanka Patel, Sameer S. Khirwadkar, Prakash M. Raole, Shishir P. Deshpande

Observations of Plasma Surface Interactions in the SST-1 and ADITYA Tokamaks Having Limiter Configuration and Estimations of Total Power Deposited During Such Interactions  
Kanchan Mahavar, Santosh P. Pandya, Shwetang N. Pandya, Kumar Ajay

Diagnostic for Monitoring Plasma Surface Interaction with Plasma Facing Components in Tokamaks and Analysis Code for Power Deposition Calculation  
Santosh P. Pandya, Kanchan Mahavar, Shwetang N. Pandya, Hitesh Patel, Kumar Ajay

Development of a Segmented Plasma Torch Assisted Simple Experimental System to be used for High Heat Flux Testing and Plasma Surface Interaction Studies  
N. Aomoa, Trinayan Sarmah, Puspallata Sah, Sameer Khirwadkar, P.M. Raole, J. Ghosh, M. Kakati

Characterization of Helium Ion Irradiation Induced Defects on Tungsten  
N. J. Dutta, N. Buzarbaruah, S. R. Mohanty

A Linear Neutron Source for Plasma Facing Material Studies  
N. Buzarbaruah, N. J. Dutta, J. K. Bhardwaz, D. Borgahain, S. R. Mohanty

Estimation of Erosion in the Tungsten Divertor Plates during ELMs  
S. Adhikari, K. S. Goswami

Optical Emission Spectroscopic Study of Argon-Hydrogen Plasma used for Smelting Reduction of Iron Ore  
Sarita Das, Debi Prasad Das, Chinmaya Kumar Sarangi, Bhagyadhar Bhoi, Joydeep Ghosh

On The Role of Fast Neutrals in the Process of Blob Formation in Low Temperature Plasmas  
G. Sahoo, R. Paikaray, S. Samantaray, P. S. Das, J. Ghosh, M. B. Chowdhuri, A. Sanyasi

Simulation of Plasma flow in the SST-1 Tokamak  
M. Himabindu, Anil Tyagi, Devendra Sharma, R. Srinivasan

Development of a High Power Pulsed Plasma Gun  
S. Borthakur<sup>1</sup>, N. Talukdar, N. K. Neog, T. K. Borthakur, R. Kumar, R. Verma, A. Shyam

Dust Flow Field Analysis in Non-Uniform Boundary Plasma Set Ups  
Laishram Madhuchandra

Particle Charging and Its Effect on Plasma Properties in Magnetically Confined Plasma  
D. Kalita, B. Kakati, S. S. Kausik, B. K. Saikia

Experiments in a double plasma device  
P. Hazarika, B. K. Das, M. Chakraborty, M. Bandyopadhyay

Design and Development of Helicon Plasma Source for Ion-Ion Plasma Experiment  
N. Sharma, M. Chakraborty, N. K. Neog, M. Bandyopadhyay

Studies on Structural and Morphological Properties of Tungsten Nanoparticles synthesized by a Plasma Expansion Technique  
Trinayan Sarmah, Puspallata Sah, N. Aomoa, M. Kakati

Study of Magnetic Properties of Iron oxide Nanoparticles Prepared by Supersonic Nozzle Expansion Plasma Method  
Lavita Sarma, Trinayan Sarma, N. Aomoa, M. Kakati

**4th Indo-Russian collaboration workshop, IPR, Bhat, Gandhinagar, 25-27 November 2014**

R&D in Alumina Coatings for IN-LLCB TBS Application  
Nirav I. Jamnapara

**11th International Workshop on Non-neutral Plasmas, Takamatsu, Japan, 1-4 December 2014**

Inertia driven radial breathing and nonlinear relaxation in cylindrically confined pure electron plasma  
M. Sengupta and R. Ganesh

**PPM-3 Technical Session, ITER-India, Gandhinagar, 2 December 2014**

I-Radiation, Hazards and Human Safety  
Sanjeev Varshney

**Sokendai Asian Winter School – 2014 (AWS-2014), Graduate University for Advanced Studies (SOKENDAI), Department of Fusion Science, National Institute for Fusion Science (NIFS), Toki City, Gifu, Japan, 2-5 December 2014**

Recent results from Infrared Imaging Diagnostics for the ADITYA and SST-1 Tokamaks

Santosh P. Pandya, Shwetang N. Pandya, Shamsuddin Shaikh, Zubin Shaikh, Kanchan Mahavar, Kumar Ajay, J. Govindarajan, ADITYA and SST-1 Team

Development of a 0-D code for the simulations of runaway electron production, energy dynamics in Tokamaks and benchmarking of the code  
Santosh P. Pandya

**National Seminar and Exhibition on Non-Destructive Evaluation (NDE-2014), Pune, India, 4-6 December 2014**

Various Infrared Thermography techniques for qualitative control of Tungsten Monoblock type Divertor targets  
Yashashri Patil, S.S. Khirwadkar, T. Patel, N. Patel, P. Mokaria, P. Patel

**25th National Symposium on Cryogenics, University of Hyderabad, Hyderabad, Telangana, 8-10 December 2014**

Results from test bench operation of SPINS, the indigenous Plasma fuelling device

J. Mishra, R. Gangradey, S. Mukherjee, P. Panchal, P. Nayak, P. Bairagi, H. Sharma, H. Patel, P. Dutta, N. Rastogi, J. Agarwal and N. Ravi Pragash

Operational Characteristics of Nbi Cryo-Condensation Pumps

B. Pandya, A.K. Sahu, S.K. Sharma, V. Prahlad, L.K. Bansal, B. Choksi, S.L. Parmar, N. Contractor, B. Sridhar, L.N. Gupta, P. Bharathi, V. Vadher, S. Rambabu, D. Thakkar, K. Qureshi, C.B. Sumod, P.J. Patel and U.K. Baruah





Operational Experience of Cryosystem Down to 3.8 K for Hydrogen Cryopumping of Neutral Beam Injection System of SST-1

A. K. Sahu, B. Pandya, L. K. Bansal, S. K. Sharma, P. Bharathi, B. Choksi, S. Parmar, N. Contractor, V. Vadher, L. N. Gupta, D. P. Thakkar, C. B. Sumod, V. Prahlad, P. Patel, U. K. Baruah

Development of Friction Welded Dissimilar Metal Joint between Al and Ss304l Pipes for Cryogenic Application

H. Vyas, A K Sahu, V. J. Badheka

Effect of the Compressor Delivery Pressure on the Cooling Capacity of the Helium Plant with Modified Claude Cycle

N. Jadhav, A. K. Sahu, R K Sahoo

Optimization of Fin Thickness and Fin Density for Two-Stream (He/He) Plate-Fin Heat Exchanger of Helium Plant with Non-Linear Fluid Property Variation

P. S. Sharma, A. K. Sahu, S.V. Jain

Design, Analysis and Development Plan for Test Facility of Cryogenic Turbines

V Patel, D Patel, N C Gupta, A K Sahu, D Joshi, S Paramkusam, H Dave, D. Bohra, P. Thummar, N. Mamgain, H. Shah

Design and Optimization of Helium Gas Purifier Operating at 80 K Internal to the Cold Box of Helium Refrigerator/Liquefier Plant

D. Bohra, A. Behera, A. K. Sahu, J M Patel

Design and Optimization of Helium Gas Purifier Operating at 20 K Internal to the Cold Box of Helium Refrigerator/Liquefier Plant

A Behera, D. Bohra, A. K. Sahu, R. K. Sahoo

Performance Assessment of the Test Facility for Pre-Series Cryoline of ITER

Choukekar Ketan, Kapoor Himanshu, Srinivasa Muralidhara, Shah Nitin, Garg Anuj and Sarkar Biswanath

Study on the Vibration Coupling Between Rotating Machine and Interfacing Helium/Nitrogen Gas Piping Network

Uday Kumar, Ketan Choukekar, Mohit Jadon, Vinit Shukla, Nitin Shah and Biswanath Sarkar

Parametric Study on TACB Thermal Shield Cool-Down: Effects of Various Flow Conditions

Jotirmoy Das, Hitensinh Vaghela, Ritendra Bhattacharya,

Pratik Patel, Ketan Choukekar, Vinit Shukla, Nitin Shah and Biswanath Sarkar

Experimental Evaluation of Transient Convective Heat Transfer Phenomenon during Loss of Insulation Vacuum for a Representative Cryoline

Srinivasa Muralidhara, Himanshu Kapoor, Ketan Choukekar, Nitin Shah, Anuj Kumar Garg, Biswanath Sarkar, Vikas Gaur, Sunil Mokhalwar, Bikash Ranjan Dash, Shk Madeenavalli

Energy based analytical investigation of cryogenic loop of Test Auxiliary Cold Box

Pratik Patel, Hitensinh Vaghela, Ritendra Bhattacharya, Srinivasa Muralidhara, Jotirmoy Das, Vinit Shukla and Biswanath Sarkar

Analytical investigation of process pipe failure in Cryo-line: Impact of different crack sizes

Vinit Shukla, Hitensinh Vaghela, Nitin Shah, Ketan Choukekar, Uday Kumar, Biswanath Sarkar

***29th National Symposium on Plasma Science & Technology and the International Conference on Plasma & Nanotechnology, Mahatma Gandhi University, Kottayam, Kerala, India, 8-11 December 2014***

Study of Role of Toroidal Field Topology on Flow and Fluctuation in Simple Toroidal Device

Umesh Kumar, T.S.Goud, R.Ganesh, D.Raju, Y.C.Saxena

Analytical Estimate of Phase Mixing Time of Longitudinal Akhiezer - Polovin Wave

Arghya Mukherjee, Sudip Sengupta

Effect of Trapped Particle Nonlinearity on Ion Acoustic Wave

Debraj Mandal, Devendra Sharma

Spectroscopic Investigation of High Density Plasma Beam with N<sub>2</sub>/H<sub>2</sub> Gas Mixtures

Parvathi S. Mohan, B. Ganguli

Polarization Reversal of Helicon Wave in Non-Uniform Plasma

Sonu Yadav, K K Barada, P K Chattopadhyay, S K Pathak, J Ghosh

Vlasov-Poisson Systems and Collisionless Plasmas - Towards Langmuir Turbulence

Pallavi Trivedi, R. Ganesh

- Investigations of Chaotic Transitions in Argon and Neon Gas Discharges  
Anu Philip, Prijil Mathew, Sajith Mathews T, P.J Kurian, P.K Chattopadhyay
- Kolmogorov Flows in 2D Strongly Coupled Complex Plasmas  
Akanksha Gupta, Rajaraman Ganesh, Ashwin Joy
- Inverse Mirror Plasma Experimental Device (IMPED) – A Magnetized Linear Plasma Device with a Wide Operating Range for Wave Studies  
Sayak Bose, P.K. Chattopadhyay, J. Ghosh and Y.C. Saxena
- Measurement of Ion Flow Velocities at the Sheath Boundary Using Ion Doppler Shift Spectroscopy in Low Temperature Plasmas  
Vara Prasad.K, Joydeep Ghosh, Nilam Ramaiya, Niral Vireni, M. B. Chowdhuri, R. Manchanda, S. Banerjee
- Synchronization of Self Oscillatory Oscillations between Two DC Glow Discharge Plasmas  
Neeraj Chaubey, S. Mukherjee, A.N.Sekar Iyengar, A.Sen
- Investigation of Dynamics in a DC Plasma Torch  
Vidhi Goyal and G. Ravi
- On the Effect of Base Pressure on Plasma Containment  
G. Sahoo, R. Paikaray, S. Samantaray, P. S. Das, N. Sasini, J. Ghosh, M. B. Chowdhuri, A. Sanyasi
- Electric Potential in a Plasma Consisting of Finite Temperature Negative Ions Produced From Cs- Coated Dust Particles  
Ananya Phukan, P J Bhuyan, K S Goswami
- On The Magnets for the Multi Cusp Magnetic Field for Confining Quiescent Alkali Plasma  
A. D. Patel, Meenakshi Sharma, A. Amardas, N. Ramasubramanian, and P. K. Chattopadhyay
- Inhomogeneous Downstream Plasma in an Expanding Radio Frequency Plasma System  
Soumen Ghosh, Prabal K. Chattopadhyay
- Observation of Electron Temperature Gradient in Magnetized Plasma Column  
S. K. Karkari, H. Kabariya, S. Gandhi, D. Patel, C. Soneji, P. Bawankar
- Studies of the Role of Diamagnetic Drift on Plasma Diffusion across a Transverse Magnetic Field  
P. Hazarika, B.K. Das, M. Chakraborty, M. Bandyopadhyay
- Nonlinear Analysis of Floating Potential Fluctuation Using Laser Heated Emissive Probe Developed Under National Fusion Program  
Vramori Mitra, Payal Mehta, Bornali Sarma, ANS Iyengar, S. Janaki, Joydeep Ghosh, Arun Sarma
- Precision Control & Monitoring of Heat Pipe Oven Temperature Using MODbus Protocol on LabVIEW for the Plasma Wakefield Accelerator Source  
Pooja Bhatt, Chirag S. Dalal, Chhaya K.Chavda, K K Mohandas, V. Sivakumaran, Sneha Singh, Ravi A. V. Kumar
- Vapour Density Diagnostics for the IPR-PWFA Lithium Heat Pipe Oven  
K K Mohandas, V. Sivakumaran, Sneha Singh, Sonam Brambhatt, Ravi A. V. Kumar
- Electrical Technique to Improve Anomalous Diffusion across a Transverse Magnetic Field  
B. K. Das, P. Hazarika, M. Chakraborty, M. Bandyopadhyay
- Design of a Line Type Pulsed Modulator for S-Band Magnetron for SYMPLE  
Priyavandna J. Rathod, Anitha V. P, G. Veda Prakash, Z. H. Sholapurwala
- Conceptual Design of a Permanent Ring Magnet Based Helicon Plasma Source  
Mainak Bandyopadhyay, Dass Sudhir, Arun Pandey, Arun Chakraborty
- Determination of RF and Extractor Power Supply Parameters for the Helicon Plasma Source System  
N. Sharma, M. Chakraborty, N.K. Neog, M. Bandyopadhyay
- Observation of Pressure Gradient Driven EMHD Turbulence in Asymmetric Electron Belt Plasma of LVPD  
A. K. Sanyasi, L. M. Awasthi, S. K. Mattoo, P. K. Srivastava, S. K. Singh, R. Singh, P. K. Kaw
- Resistive Wall Destabilization of Electron Plasmas in SMART-TEX-C  
Lavkesh T. Lachhvani, Manu Bajpai, Prabal K. Chattopadhyay, Sambaran Pahari



- A Physical Model Explaining ETG Suitable Plasma in LVPD by EEF Field Modulation  
A. K. Sanyasi, L. M. Awasthi, P. K. Srivastava, Prabhakar Srivastava, S. K. Mattoo
- Fluctuation Induced Particle Flux in the Background of ETG Plasma: Possible Case of Intermittency  
Prabhakar Srivastava, L. M. Awasthi, A. K. Sanyasi, P. K. Srivastava, R. Jha, S. K. Mattoo
- Interface Software Development, Integration and Performance Results of the High Current Power Supply in Large Volume Plasma Device  
R. Sugandhi, P. K. Srivastava, A. K. Sanyasi, Prabhakar Srivastava, L. M. Awasthi, S. K. Mattoo, Kaushik Patel, Radhe Panchal, Varunesh Kumar
- Architecture of Control and Data Acquisition System of Applied Plasma Physics Experiments in Linear Device  
Ritesh Sugandhi, S. Karkari
- A Novel Approach to the Study of Hysteresis, and Negative Resistance in Glow Discharge Plasma  
Prijil Mathew, Anu Philip, Sajith MathewT, P.J. Kurian, P.K. Chattopadhyay
- Characterization of Ionizer hot plate for Multi-Cusp Plasma Device (MPD)  
Zubin Shaikh, Meenakshi Sharma, A.D.Patel, J.D.Khatri, S.Sahoo, H.H.Joshi, N.Ramasubramanian
- Particle in Cell Simulation of Buneman Instability  
Roopendra Singh Rajawat, Sudip Sengupta, Predhiman K. Kaw
- Study on Discharge Dynamics in an Atmospheric Pressure Dielectric Barrier Discharge  
S.S. Kausik, W.H. Tay, S.L. Yap, C.S. Wong
- Evolution of Relativistic Electron Current Beam in a Cold Plasma  
Roopendra Singh Rajawat, Sudip Sengupta
- Numerical Study on Second Harmonic Ion Cyclotron Resonance Heating of Low Ion Temperature Plasma  
Asim Kumar Chattopadhyay
- Development of a 0-D Code for the Simulation of Runaway Electron Production and Energy Dynamics in Tokamaks  
Santosh P. Pandya
- Investigation of Phase Equilibria and Critical Properties of Strongly Coupled Pair Ion Plasmas  
Swati Baruah, R. Ganesh, K. Avinash
- Fate of an Electron Plasma Subjected to Ion Resonance Instability: A Numerical Study at Arbitrary Aspect Ratio  
M. Sengupta, R. Ganesh
- Modelling of Disruption for ITER Using TSC Code  
Amit K. Singh, Indranil Bandyopadhyay
- Molecular Dynamics Simulation of Plasma Sheath  
Sandeep Kumar, Amita Das, Sanat Kumar Tiwari
- Effect Of Ion-Neutral Collision on the Spatial Potential of a Dust Grain  
R. Moulick, K. S. Goswami
- Avoiding Disruptions and Runaways in ITER  
Indranil Bandyopadhyay
- Guiding Center Trajectory of Electron Plasma Cloud Using Capacitive Probe Diagnostics in SMARTEX-C  
Lavkesh T. Lachhvani, Sudip Sengupta, Manu Bajpai, Prabal K. Chattopadhyay, Sambaran Pahari
- Experimental Study of Linear Dust Acoustic Waves in Inhomogeneous Dusty Plasmas  
J. Pramanik, P Patra, P.Sen, D.Banerjee
- Coupling of Drift Wave with Dust Acoustic Wave  
Atul Kumar, Amita Das
- Experimental Characterization of Complex Plasma in DPEx  
Surabhi Jaiswal, P. Bandyopadhyay, A. Sen
- Preliminary Studies of a Warm Dense Plasma Produced By Electrically- Exploded Conductors  
Aditya Nandan Savita, Sambaran Pahari, Aaditya V. Majalee, Neeraj Shiv, Kshitish Barada, Joydeep Ghosh, Shashank Chaturvedi
- Instability of a Vortex in A Strongly Coupled Dusty Plasma  
Sayanee Jana, Debabrata Banerjee, Nikhil Chakrabarti
- Self-Organized Poloidal Dust Rotation in DC Glow Discharge and Its Evolution with Gas Pressure

- Manjit Kaur, Sayak Bose, P. K. Chattopadhyay, D. Sharma, J. Ghosh, Y. C. Saxena
- Dust Flow Field Analysis in Non-Uniform Boundary Plasma Setups  
Modhuchandra Laishram, Devendra Sharma, Predhiman K. Kaw
- Interaction of Dust Acoustic Waves with Dust Voids  
Rinku Mishra, M.Dey
- Properties of Gravitationally Equilibrated Yukawa Systems-A Molecular Dynamics Study  
Harish Charan, Rajaraman Ganesh, Ashwin Joy
- Numerical Investigation of the Forced Kadomtsev-Petviashvili (fKP) Equation in a Complex Plasma  
Madhurima Choudhury, P. Bandyopadhyay, Abhijit Sen
- Delayed Charging Effects on the Kelvin-Helmholtz Instability in Complex Plasma  
Debabrata Banerjee
- A Numerical Study of Rayleigh-Taylor Instability in Strongly Coupled Dusty Plasma Medium  
Vikram Singh Dharodi, Amita Das, Sanat Kumar Tiwari
- Dust Charging In Presence of Magnetic Field in Low Pressure Hydrogen Discharge  
D. Kalita, B. Kakati, B.K. Saikia, M. Bandyopadhyay
- Design of a System to Study Charged Dust Grains in RF Plasma  
S.S. Kausik, B.K. Saikia, C.S. Wong
- Diagnostics of Plasma Mode Switching in Inverted Polarity Planar Magnetron  
Samir Chauhan, Mukesh Ranjan, Subroto Mukherjee
- Study of Transient Electric Fields in Capacitively Coupled Discharges  
Sarveshwar Sharma, Sanjay K. Mishra, Predhiman K Kaw
- Phasor Voltage Network Method for Determining Electrical Model of 13.56MHz RF Plasma and Its Matching Network for Low Power Industrial Application  
Anand Visani, Vishal Jain, Purvi Kikani
- Investigation of the Current –Voltage Characteristics of a DC Non-Transferred Arc Plasma Torch Using Heat Balance Measurements  
Yugesh.V, Gavisidayyah Hiremath, G. Ravi, K. Ramachandran
- Ballistic Deposition Model for Structure and Morphology of Vapor Deposited Thin Films  
N. Vijay, P.N. Maya, S.P. Deshpande
- Relativistic Electron Beam Driven Wake-Field Excitation in a Cold Plasma  
Ratan Kumar Bera, Amita Das, Sudip Sengupta
- Relativistic Electromagnetic Cusp Soliton in Plasma  
Deepa Verma, Amita Das, Predhiman Kaw, Sanat Kumar Tiwari
- Energy Coupling During Nano and Pico Second Pulsed Laser Shock Peening of Stainless Steel and Aluminum Surfaces  
P.Venkateshwarlu, Pardhu Yella, Ramesh Kumar Buddu, Raole P.M., K. Bhanu SankaraRao, Koteswararao V. Rajulapati, P. Prem Kiran
- Classical Radiation Reaction Effects on Laser Driven Auto-Resonant Particle Acceleration  
Vikram Sagar, Sudip Sengupta, P.K.Kaw
- Particle in Cell Simulation of Non-linear Evolution Filamentation Instability in Counter-streaming Relativistic Beams  
Chandrasekhar Shukla, Bhavesh G. Patel, Kartik Patel, Amita Das
- External Magnetic Field Induced Instabilities in Laser-Produced Plasma  
Narayan Behera, R. K. Singh, Ajai Kumar
- Dynamics of Shock Wave and Cavitation Bubble Produced By Laser Ablation of Cu in Water  
Alamgir Mondal, R.K. Singh, Ajai Kumar
- Development of Beam Diagnostic for 400 MeV Proton Beam Intensity Using Chromox-6 Scintillation Screen at Fermilab MuCool Test Area  
M. R. Jana, M. Chung, B. Freemire, M. Leonova, A. Moretti, M. Palmer, A. Tollestrup, Y. Torun, K. Yonehara
- Study of Impurities in Vacuum Vessel in Different Campaigns of SST-1  
Kalpesh R. Dhanani, Ziauddin Khan, D. C. Raval, Siju





George, Y. Paravastu, P. Semwal, G. Ramesh, F. S. Pathan, M.S.Khan, S. Pradhan

DAC Controlled Voltage Variable RF Attenuator for Generating RF Pulses of Different Shapes and Amplitudes for ICRH System

Manoj Singh, HM Jadav, Ramesh Joshi, Sunil Kumar, Srinivas YSS, SV Kulkarni, RF-ICRH group

Helium Ion Irradiation on the Materials Relevant To Fusion Research

N.J. Dutta, N. Buzarbaruah, S.R. Mohanty

Development of IECF Based Linear Neutron Source at CPP-IPR and Its Current Status

N. Buzarbaruah, N.J.Dutta, J.K.Bhardwaz, D. Borgahain, S.R.Mohanty

RF Pulse Control for ICRH Heating Experiment in ADITYA  
H M Jadav, Manoj Parihar, Ramesh Joshi, Sunil Kumar, S.V. Kulkarni

ICRH DAC Software Modifications for ICRH Experiments in ADITYA

Ramesh Joshi, H M Jadav, Manoj Parihar, B R Kadia, K M Parmar, A Varia, Gayatri Ashok, Y S S Srinivas, Sunil Kumar, S.V. Kulkarni

High Temperature Vacuum Baking Of PFC Graphite Tiles of SST-1

Gattu Ramesh Babu, Y. Paravastu, Arun Prakash, Ziauddin Khan, S. Pradhan

Commissioning Of 10kV, 7A HVDC Integrated Power Supply for Triode Based 20KW Stage CWRF Amplifiers

Kirit M Parmar, Bhavesh R Kadia, YSS Srinivas, H M Jadav, Ramesh joshi, SV Kulkarni and ICRH group

Commissioning Of Integrated Power Supply (15kV, 28A and Three Auxiliary Supplies) for Testing of 200kW Stage CWRF Amplifiers

Bhavesh R Kadia, YSS Srinivas, Kirit M Parmar, H M Jadav, Ramesh joshi, Sunil Kumar, S V Kulkarni, ICRH group

Design and Development of Protection Circuits for High voltage Power Supplies used in various stages of 1.5 MW CWRF Amplifier

Bhavesh R Kadia, YSS Srinivas, Kirit M Parmar, S.V.

Kulkarni & ICRH Group.

Development, Testing and Integration with DAC of 450 A DC Filament Power Supply For 200 KWCWRF Amplifier

Bhavesh R Kadia, Kirit parmar, YSS Srinivas, H. M. Jadav, Azad Makwana, S.V. Kulkarni & ICRH Group

2D Thermal Design Validation of Use of Beryllium as Plasma Facing Material and Cucrzr as Heat Sink Material for Iter Shiled Blanket Module First Wall

Ritesh Kumar Srivastava, Paritosh Chaudhari

Study the Effect of Thermal Cyclic on SS316L to CuCrZr Brazed Joint Sample

K.P Singh, Alpesh Patel , Kedar Bhope, S S Khirwadkar, S Belsare, Nikunj Patel, Prakash Mokaria

Glow Discharge Wall Conditioning System of SST-1

D.C.Raval, Ziauddin Khan, Kalpesh R. Dhanani, Siju George, P. Semwal, Y. Paravastu, G. Ramesh, F. S. Pathan, M. S. Khan, S. Pradhan

The Role of E B Flows on Global Linear Microinstabilities

Deepak Verma, Aditya K. Swamy, R. Ganesh

Dynamic Heater System for Controlling the Temperature of Turbines Bearing In SST-1 Helium Cryogenic System

Dikens Christian, R. Panchal, P. Panchal, R. Patel, V.L. Tanna, S. Pradhan

Upgradation of Control System for the SST-1 LN2 Shield Distribution after Valve Box Installation

G.Mahesuria, R.Patel, R.Panchal, D.Sonara, H. Nimavat, GLN Srikanth, V.L.Tanna, S.Pradhan

Effect on Electrostatic and Magnetic Fluctuations Due To Biased Electrode in ADITYA Tokamak

Pravesh Dhyani, J. Ghosh, Y.C. Saxena, P.K. Chattopadhyay, R.L. Tanna, D. Raju, S. Joisa, S.B. Bhatt, P.K. Atrey, C.N.Gupta, C.V.S. Rao, R. Jha, ADITYA team

High-Current Long-Pulse Plasma Discharges in Aditya Tokamak

R.L. Tanna, Pintu, Kumar, J. Ghosh, K. A. Jadeja, K. M. Patel, Nilesh Patel, K.S. Acharya, S. B. Bhatt, K.S. Shah, M.N. Makawana, C.N. Gupta, M. B. Kalal, D. S. Varia, V. K. Panchal, N. C. Patel, C.Chavda, A. Amardas, D. Sangwan, Hars-hita Raj, P. K. Chattopadhyay, K. Sathyanarayana, S. K. Jha, D. Raju, M.V. Gopalkrishna, K. Tahiliani, R. Jha, S.Purohit,

- J. V. Raval, Asim Kumar Chattopadhyay, Y. S. Joisa, C.V.S. Rao, Umesh Nagora, P. K. Atrey, S.K. Pathak, N. Virani, N.Ramaiya, S. Banerjee, M. B. Chowdhuri, R.Manchanda, Kiran Patel, J. Thomas, Ajai Kumar, S.Gupta, Kumar Ajay, S. Pandya, K. Mahavar, M. Gupta, Praveenlal E.V, Minsha Shah, Praveena Kumari, R.Rajpal, S.V.Kulkarni & ICRH Group, B. K. Shukla & ECRH Group, P.K. Sharma & LHCD Group, R.Goswami, R. Srinivasan, I Bandyopadhyay, R.P. Bhattacharyay, Amit Sircar, N.Ramasubramanian, H. D. Pujara, H.A. Pathak, A. Vardharajalu, A.Das, S.P.Deshpande, K.K. Jain, Prabhat Ranjan, D. C. Reddy, D. Bora, Y. C. Saxena, S. K. Mattoo, A. Sen, P. I. John and P. K. Kaw.
- Role of Sacrificial Layer on Picosecond Laser Shock Peening of Stainless Steel Surfaces  
Pardhu Yella, P. Venkateswarlu, Koteswararao V. Rajulapati, Ramesh Kumar Buddu, Raole P.M., K. Bhanu Sankara Rao, P. Prem Kiran
- Effects of Quasi-Periodic Variation in 3D EMC3-EIRENE SOL Plasma Transport Simulation of Tokamak Aditya  
Bibhu Prasad Sahoo, Devendra Sharma, Ratneshwar Jha and Yuhe Feng
- Design and Test Results of a 200kV, 15mA High Voltage Power Supply  
Amal S, Urmil M Thaker, Kumar Saurabh, Ujjwal K Baruah
- Design of the ITER IN-DA ECE Diagnostic Transmission Line Layout and Support Structures  
Sajal Thomas, Shrishail B Padasalagi, H. K. B. Pandya, Ravinder Kumar
- Implementation of DEGAS2 Code to Study the Neutral Particle Transport in Aditya Tokamak and Its Initial Results  
Ritu Dey, Joydeep Ghosh, Malay Bikas Chowdhuri, ADITYA Team
- Plasma-Wall Interactions in Presence of Fusion Neutrons- A Modelling Perspective  
P.N. Maya, M. Warriar, C. Dube, P.M. Raole, S.P. Deshpande
- Automation and Control for Offline Impedance Matching Using PLC and LABVIEW for ICRH Transmission Line in SST-1  
Aniruddh Mali, Ramesh Joshi, Krupa Mehta, H.M.Jadav, S.V. Kulkarni
- Structural Assessment of Manufacturing Model of Iter-Cryostat Lower Cylinder, Upper Cylinder and Top Lid  
Avik Bhattacharya, Girish Gupta, Vipul More, Gaurav Jogi, Anil Bhardwaj
- Prototype High Voltage Bushing: Design and Development  
Sejal Shah, D. Sharma, M. Bandyopadhyay, C. Rotti, K. Pandya, H. Tyagi, J. Soni, D. Parmar, A. Gahlaut, H. Patel, A. K. Chakraborty
- Engineering Design of PLC Based Control and Monitoring for 100kw, 45.6 MHz ICRH DAC  
Krupa Mehta, Ramesh Joshi, Aniruddh Mali, H M Jadav, S.V. Kulkarni
- Estimation of Hard X-Ray Flux Using MCNP for the Runaway Electrons Produced In ITER Hydrogen Phase  
Rajnikant Makwana, Santosh P. Pandya, Jagannathan Govindrajan, Robin Barnsley, Michael Walsh
- Study of Castelled Divertor Gaps  
S. Adhikari, K.S. Goswami
- Neutronics Analysis and Shielding Optimization for X-Ray Crystal Spectrometer of ITER Using both MCNP and AT-TILA  
P.V. Subhash, S.Jakhar, Gunjan Indauliya, T Sai Chaitanya, Sajal Thomas, Sapna Mishra, Russell Feder, Deepak Aggarwal, Sanjeev Varshney, Shrishail Padasalagi, Vinay Kumar
- Pre-Assembly Tests of 80 K Booster Systems Cryostats and VJ lines  
R. Patel, GLN Srikanth, G. Mahesuriya, K. Patel, P. Shah, H. Nimavat, V.L. Tanna and S. Pradhan
- Overview of Instrumentation & Control System for ITER Vacuum Vessel Pressure Suppression System  
Dileep Shukla, Vipul More, Girish Gupta, Anil Kumar Bhardwaj
- Studies on Keyhole Plasma Characteristics during Laser Welding With Optical Emission Spectroscopy  
Ramesh Kumar Buddu, M. B. Chowdhuri and P.M. Raole
- Implementation of Soft Start Logic in ECRH DAC for Smooth Rise of HV in RHVPS for Reliable Operation of High Power Gyrotrons  
Jatinkumar Patel, B.K. Shukla, Harshita patel, N. Rajanbabu, Pragnesh Dhorajiya and Paresh Patel, Sumod C.B., Dipal Thakker, L.N. Gupta



Mode Analysis to Study Waves & Instabilities as an Agent for Plasma Non-Uniformity in Negative Ion Sources

Dass Sudhir, Mainak Bandyopadhyay, Arun Chakraborty

Structural Assessment of Manufacturing Model of Cryostat Base Section

Gaurav Jogi, Girish Gupta, Avik Bhattacharya, Vipul More, Anil Bhardwaj

Fabrication Methodology of ITER Cryostat

Girish Gupta, Rajnikant Prajapati, Mitul Patel, Vaibhav Joshi, Jagrut Bhavsar, Mukesh Jindal, Vipul More, Amit Palaliya, Avik Bhattacharya, Gaurav Jogi, Manish pandey, Saroj Jha, Anil K Bhardwaj, Pandurang S Jadhav

High Speed Fiber Optics Data Link for Analog Signal, Using Aurora Protocol

Jatin Upadhyay, Jignesh Soni

Design and Integration of Second Calorimeter for Neutral Beam Indian Test Facility (INTF)

Suraj Pillai, Chirag Mistry, Venkat Nagaraju, Jaydeep Joshi, Ashish Yadav, Dhananjay Kumar Singh, Rambilas Prasad, Jogendra Nandyala, Jayakar Amarlapudi, Chandramouli Rotti, Mainak Bandyopadhyay, Arun K. Chakraborty

The Operation of Cryo-Condensation Pumps with NBI Helium Cryoplant

Bhargav Pandya, A.K.Sahu, L.K.Bansal, S.K.Sharma, B.Choksi N.Contractor, S.Parmar, B.Sridhar, V.Vadher, K.Qureshi, P.Bharathi, L.N.Gupta, D.Thakkar, C.B.Sumod, V.Prahlad, S.Rambabu, P.J.Patel, U.Baruah

Thermo-Mechanical Analysis of Heat Transfer Elements (HTEs) Of Second Calorimeter for Neutral Beam Indian Test Facility (INTF)

Chirag Mistry, M. Venkatanagaraju, Jaydeep Joshi, Jayakar Amarlapudi, Chandramouli Rotti, Mainak Bandyopadhyay, Arun K. Chakraborty

Automation of Antenna-Plasma Impedance Determination and Matching in Aditya and SST-1 for ICRH

Kanjifatema Masi, Raj Singh

Observation of Poloidal Dust Rotation in Stationary Toroidal Structures

Manjit Kaur, Sayak Bose, P. K. Chattopadhyay, Devendra Sharma, J. Ghosh and Y. C. Saxena

Qualification of Liquid Penetrant Examination (LPE) Consumables for ITER Cryostat

Anil Kumar Bhardwaj, Amit Palaliya, Rajnikant Prajapati, Jagrut Bhavsar, Mukesh Jindal, Vaibhav Joshi, Mitul Patel, Gaurav Jogi, Girish Gupta, Vipul More, Avik Bhattacharya, Saroj Jha, Manish Pandey, Siva Kumar, Nayan Desai

Development of 35 KWHV Power Supply For 8KWICRF Amplifier of Ring Resonator

Kartik Mohan, Gajendra Suthar, Rohit Agarwal, Raghuraj Singh, P. Ajesh, Harsha Machchhar, JVS Hari Krishna, Manoj Patel, Kumar Rajnish, Dipal Soni, Rohit Anand, Akhil Jha, Sriprakash Verma, Pareshkumar N. Vasava, Hriday N. Patel, Hrushikesh N. Dalicha, R.G. Trivedi, Aparajita Mukherjee

Automatic Gas-Feed Control System for Vacuum Vessel

Kiran Patel, K.A. Jadeja, Ajai Kumar

MgB<sub>2</sub>-Brass Joint Resistance Optimization for SST-1 Superconducting Magnet Current Leads

Upendra Prasad, A.Bano, A.Panchal, P.Raj, P.Varmora, S.Pradhan,

Fluid Simulation of the Drift Tearing Instability

Jervis Ritesh Mendonca, Debasis Chandra, Abhijit Sen, Anantanarayanan Thyagaraja

Design and Development of Water Cooling System for High Heat Flux Test Facility at IPR

Rajamannar Swamy, S.S.Khirwadkar, Sunil Belsare, Nikunj Patel, Tushar patel, Prakash Mokaria

Conceptual Design, Development and Procurement of LT Power Distribution System for Twin Source

KG Parmar, Deepak Parmar, Agrajit Gahlaut, V Mahesh, M NVishnuDev, B. Prajapati, H.Shishangiya, Mainak Bandyopadhyay, G. Bansal, Jignesh Soni, R.K. Yadav, K. Pandya, H.Mistri and ArunKumar Chakraborty

Analysis of the Contaminated Optical Viewports Mounted on the Aditya Tokamak

Nilam Ramaiya, M.B. Chowdhuri, R. Manchanda, S. Banerjee, Niral Virani and J.Ghosh

Control and Data Acquisition System for Characterization of Microwave Components for ECE Diagnostics in ITER-INDIA Lab

Vismaysinh Raulji, Jignesh Patel, Praveena Kumari, Suman Danani, Rachana Rajpal

Overview of Indian LLCB TBM program and R&D activities  
R. Bhattacharyay, Indian TBM Team

Ethernet Based, Frequency-Programmable Sweep Generator for Langmuir Probe Biasing

Pramila, Kaushal Patel, Hitesh Mandaliya, C.J.Hansalia, Rachana Rajpal, R. Jha

Design and Development of Multi-Channel Signal Conditioning System for Soft X-Ray Imaging Camera in Aditya Tokamak

Praveena Kumari, Jignesh Patel, Vismaysinh Raulji, Jayesh V Raval, Hitesh Mandaliya, Minsha Sha, Salman Ansari, Praveen Lal E.V, C J Hansalia, Y S Joisa, Rachana Rajpal, R Jha

Automation of Aditya Test Stand Vacuum Facility Using Siemens S7- 300 PLC

Bharat Arambhadiya, Vismaysinh Raulji, Kumarpalsinh Jadeja, Kaushal Patel, Shailesh Bhatt, Rachana Rajpal, Dr. Joydeep Ghosh

Design, Implementation and Optimization of High Speed Ethernet Network for I & C Interfacing at High Heat Flux Test Facility

R.Sugandhi, T. Patel, R.Roshan, S. Khirwadkar

Preliminary Design of 4kV, 1A Series Connected IGBT Switch for Triode Based ICRH Amplifier Protection

Mandeepsingh Chhabada, Bhavesh Kadia, Y.S.S. Srinivas, S.V. Kulkarni

Engineering Design of Beam Transmission Duct and Shine-Through Armor for SST-1

S.Rambabu, S.K.Sharma, B.Sridhar, P. Bharathi, V Prahlad, U.K Baruah

Digital Signal Processing on FPGA for Plasma Diagnostics  
Hitesh Mandaliya, Rachana Rajpal, Abhijeetkumar, R. Jha

Structural Fabrication: Study of Infrastructure Facilities Required To Convert Concept to Reality

Gautam R Vadolia

Recent Result of Better Plasma Performance Using Lithium Coating in Aditya Tokamak

K.A. Jadeja, K. M. Patel, S. B. Bhatt, J. Ghosh, R. L. Tanna, N. D. Patel, K. S. Acharya, Niral Patel, Nilam Ramaiya, M.

B. Chowdhuri, Manoj Kumar, Pintu Kumar, S. Joisa, P. K. Atrey, C. N. Gupta, J.V. Raval, U. C. Nagora, Ajai Kumar, R. Jha and Aditya Team

Design, Fabrication, Assembly, Installation and Testing of the Beam Intercept for Negative Ion Beam Profile Measurement in ROBIN

K.Pandya, G.Bansal, J.Soni, H.Tyagi, H.Mistry, A.Gahlaut, K.G.Parmar, V.Mahesh, B.Prajapati, R.K.Yadav, M.Bandyopadhyay, A.Chakraborty

Vacuum Vessel Baking of Aditya Tokamak for Improved Plasma Operation

K. M. Patel, Kiran Patel, K. A. Jadeja, K. S. Acharya, S. B. Bhatt, M. B. Kalal, Nilesh Patel, Mitul Raval, R. L. Tanna, Pintu Kumar, D. S. Varia, N. C. Patel, Santosh Panya, K. Mahavar, J. Ghosh, P.K. Chattopadhyay, Y. C. Saxena and Aditya Team

A Tritium Transport Model for Lead Lithium Cooled Ceramic Breeder (LLCB) Test Blanket Module (TBM) System  
Priyanka Brahmabhatt, Amit Sircar and E. Rajendra Kumar

Design and Analysis of Sparger for Hydrogen Isotopes Saturation in Liquid Lead Lithium

Sudhir Rai, Amit Sircar

Design of Cryogenic Molecular Sieve Bed Adsorber System for Hydrogen Isotopes Removal System

V. Gayathri Devi, Amit Sircar, B. Sarkar, Himanshu Kapoor, Deepak Yadav

Design and Development of a Cold Trap for Regeneration of Atmospheric Molecular Sieve Bed in Hydrogen Isotope Removal System

Deepak Yadav, V Gayathri Devi, Amit Sircar

Fabrication, Testing & Commissioning of Electrical Interfaces as a Test Facility at ITER-India Lab for ITER like R&D ICRF Source

Gajendra Suthar, Kartik Mohan, Rohit Agarwal, Hrushikesh N. Dalicha, Raghuraj Singh, P. Ajesh, Kumar Rajnish, R.G. Trivedi, Aparajita Mukherjee

Safety Key Lock management system at ITER-India Lab for overall safety during testing of ITER like R&D ICRF source  
Rohit Anand, Kartik Mohan, Gajendra Suthar, P. Ajesh, Ro-





hit Agarwal, Raghuraj Singh, Harsha Machchhar, JVS Hari Krishna, Manoj Patel, Kumar Rajnish, Dipal Soni, Akhil Jha, Sriprakash Verma, Pareshkumar N. Vasava, Hriday N. Patel, Hrushikesh N. Dalicha, R.G. Trivedi, Aparajita Mukherjee

An Overview of Coaxial Transmission Line Components for ITER ICH&CD System

Harsha Machchhar, R.G. Trivedi, Raghuraj Singh, Kumar Rajnish, P. Ajesh, Manoj Patel, JVS Hari Krishna, Akhil Jha, Rohit Agarwal, Gajendra Suthar, Dipal Soni, Rohit Anand, Sriprakash Verma, Pareshkumar N. Vasava, Hriday N. Patel, Hrushikesh N. Dalicha, Aparajita Mukherjee

Conceptual Design and Development Status of Mismatch Transmission Line (MMTL) to Test RF Power Sources for ITER ICH&CD System

Raghuraj Singh, R.G. Trivedi, Kumar Rajnish, P. Ajesh, Harsha Machchhar, Manoj Patel, JVS Hari Krishna, Akhil Jha, Rohit Agarwal, Gajendra Suthar, Dipal Soni, Rohit Anand, Sriprakash Verma, Pareshkumar N. Vasava, Hriday N. Patel, Hrushikesh N. Dalicha, Aparajita Mukherjee

Development, Testing and Integration of Signal Conditioning Board with Local Control Unit of R&D ICRF Source

Kumar Rajnish, Dipal Soni, Manoj Patel, Sriprakash Verma, Hriday Patel, Gajendra Suthar, Harsha Machchhar, Raghuraj Singh, P. Ajesh, Rohit Anand, R.G. Trivedi, Aparajita Mukherjee

Exploring the Capability of ATTLA Code Along with Its FORNAX Activation and Transmutation Data Base for Dose Rate Calculations in ITER like Geometry

Deepak Aggarwal, Chandan Danani

Parametric Study of Residual Stresses in Multi-Pass Welding For a Fusion Grade Reactor

Manoah Stephen M, Ravi Prakash, Ranjana Gangradey  
Engineering Methodology for Bolt Design of In-Vessel Structure for a Fusion Grade Reactor  
Manoah Stephen M. Ravi Prakash

Engineering Design Methodology of end and Central Support for in Vessel Structure for a Fusion Grade Reactor

Ravi Prakash, Manoah Stephen M

Activation Analyses of Indian-LLCB TBM-Set for ITER Irradiation Scenarios

A K Shaw, H L Swami, D Aggarwal, C Danani

Piping Flexibility Analysis of High Pressure High Tempera-

ture Experimental Helium Cooling Loop

Aditya Kumar Verma, Brijesh Kumar Yadav, Ankit Gandhi, E.Rajendra Kumar

Isolated Analogue Signal Measurement Units with High Speed Voltage to Frequency Converters

Tejas Patel, Vinod Patel, Sandip Raiyani, Amit Patel, Aruna Thakar

Improved Electronics for Langmuir Probe Diagnostics for APPEL Device

C.Hansalia, G.Priyadarshini, Pramila, H.Kabariya, R.Rajpal, S.Karkari, R.Jha

Preliminary Design of Instrumentation & Control for Experimental Helium Cooling System

T. Srinivas Rao, Ahishek Saraswat, D. Mohanta, E. Rajendra Kumar

Effect of Bending Strain on Critical Current of YBCO, BSCCO and Di-BSCCO High Temperature Superconducting Tapes

Piyush Raj, Anees Bano, Arun Panchal, Mahesh Ghate, Subrata Pradhan

Testing of Process Sensors for High Temperature Liquid Metal Applications

Abhishek Saraswat, T. Srinivas Rao, Srikanta Sahu, Ashok Prajapati, Sandeep Gupta, Rajendra P Bhattacharyay, E. Rajendra Kumar

1-D Neutronic Shielding Analyses for ITER like Fusion Devices

H L Swami, C Danani

A Comparative Study on Fusion Reactor/Iter Structural Materials Activation Analyses

H L Swami, A K Shaw, D Aggarwal

Spectroscopic Observations in SST-1 Tokamak

R. Manchanda, M. B. Chowdhuri, Nilam Ramaiya, Niral Virani, J.Ghosh, SST-1 team

Signal Conditioning and Integrator Electronics for Hard X-Ray Flux/Intensity Measurement Diagnostic in Aditya Tokamak

Minsha Shah, Rachana Rajpal, Praveenlal Edappala, C J. Hansalia, Jayesh Raval, Shankar Joisa

Neutronics Analysis of the 40 Degree CAD Model of ITER with the 3-D Deterministic Neutron Transport Code, ATTILA  
Deepak Aggarwal, C Danani, B J Saikia, M Z Youssef

Study of Disruptive Termination of the Aditya Plasma Discharges  
S. Purohit, Y.S. Joisa, M. B. Chowdhuri, J.V. Raval, J. Ghosh, R. L. Tanna, D. Raju, C. N. Gupta, S. B. Bhatt, R. Jha and Aditya team

Design of a Timing Circuit for HPM - Plasma Interaction Experiments  
Praveenlal Edappala, Rachana Rajpal, Hitesh Mandaliya, Salman Ansari, R Jha, Priyavandna J Rathod, Anoop Sushcel, Nasir Shah, Saurabh Kumar, Rajesh Kumar, Anitha V P

Fundamental and Second Harmonic ECRH Assisted Plasma Start-Up in Tokamak SST-1  
B. K. Shukla, S. Pradhan, Paresh Patel, Rajan Babu, Jatin Patel, Harshida Patel, Pragnesh Dhorajia, Prashant Singh, R. Jha, D. Bora, RHVPS Division, WCS Division, APPS Division, Diagnostics Division and SST-1 Team

Design of Mode Selective Coupler for 42GHZ, 200kW 3 Sec DST-Gyrotron  
Shaik Ejazuddin, B.K. Shukla, S.V. Kulkarni and D. Bora

Multi-Field Characterization of Geodesic Acoustic Modes (GAMs) In SINP Tokamak  
Lavkesh T. Lachhvani, Joydeep Ghosh, P. K. Chattopadhyay, Nikhil Chakrabarty, Rabindranath Pal

Throughput Calibration of Gas Dosing Valve For Pumping Speed Study of Indigenously Developed Fusion Grade Cryopump  
Pratikumar Nayak, Paresh Panchal, Samiran Mukharjee, RanjanaGangradey, S. Kasthurirangen

Design and Analysis of a Rotating Tritium Target Holder for 14-MeV Neutron Generator  
Anuraj.R, Dhaval Rajyaguru, SudhirsinhVala, C.V.S. Rao, T.K.Basu and B. Sarkar

Effect of TF Ripple on the Performance of Tokamak Plasmas  
A. Amardas, R.L. Tanna, J. Ghosh, P.K. Chattopadhyay, M.B. Kalal, D.Raju, J.V. Raval, S. Purohit, Y.S. Joisa, C.V.S. Rao, Umesh Nagora, P.K. Atrey

Test Results of 3MW RF Dummy Load & 10kW Solid State

RF Power Amplifier for ITER ICRH Frequency Range  
Akhil Jha,Manoj Patel, Rohit Agarwal, Raghuraj Singh, P. Ajesh, Harsha Machchhar, JVS Hari Krishna,Gajendra Suthar, Kumar Rajnish, Dipal Soni, Rohit Anand, Sriprakash Verma, Pareshkumar N. Vasava, Hriday N. Patel, Hrshikesh N. Dalicha, R.G. Trivedi, Aparajita Mukherjee

Development of UHV Compatible Wilson Feed-Through for Probe Drive  
K. M. Patel, K. A. Jadeja, K. S. Acharya, S. B. Bhatt, J. Ghosh, P. K. Chattopadhyay

R&D Activity for ITER ICRF Power Source System  
Rajesh Trivedi , Aparajita Mukherjee, Raghuraj Singh, Kumar Rajnish, Harsha Machchhar, P. Ajesh, Gajendra Suthar, Dipal Soni, Manoj Patel, Kartik Mohan, Jvs Hari, Rohit Anand, Sriprakash Verma, Rohit Agarwal, Akhil Jha, Pareshkumar N. Vasava, Hriday N. Patel, Hrshikesh N. Dalicha

Improved Plasma Parameters Using Upgraded Ohmic Capacitor Bank Power Supply in ADITYA Tokamak  
M.B. Kalal, R.L. Tanna, Pintu Kumar, D.S. Varia, Kunal Shah, K. Sathyanarayana, P.K.Chattopadhyay and Joydeep Ghosh

The Outgassing Study of Cryogenic Sealing & Support Material for Indigenous Cryopump  
Paresh Panchal, Jyoti Agrawal, Samiran Mukherjee, Ranjana Gangradey

Pumping Performance Study for Cryopump with the use of Test Particle Monte Carlo Simulation for Cryopump Development  
Rana Chirag, Ranjana Gangradey, Ravi Prakash, Samiran Mukherjee, Jyoti Aggrawal

Studies of Microstructure, Delta Ferrite and Ferrite Number in Multi-Pass TIG Welded 25mmThick SS304  
Shamsuddin Shaikh, Sandip Bhagvat, N.L.Chauhan, Krushnsinh Garasia, Ramesh Kumar Budduand, P.M.Raole.

Generation and Transport of Saw-Teeth Induced Runaway Electrons in Aditya Tokamak  
Harshita Raj, Joydeep Ghosh, R. L. Tanna, P. K. Chattopadhyay, D. Raju, S. K. Jha, J. Rawal, S.Joisa, S. Purohit, CVS Rao, P. K. Atrey, Rabindranath Pal

Thermal Imaging of SST-1 Limiters and Calculation of Heat Flux Deposition and Estimation of Total Power Drawn Limiters



Kanchan Mahavar, Santosh P. Pandya, Hitesh Patel, Shwetang N. Pandya, Kumar Ajay and SST-1 Team

An Estimation of Neutral Hydrogen Density as well as the Ion Temperature in the Core Regime of Aditya Plasma Using the Energetic Charge Exchange Neutral Spectrum as Obtained on The Channels of Neutral Particle Analyzer[NPA] for Several APPS Discharges  
Kumar Ajay, Snehlata Gupta, Santosh P. Pandya, J. Govindarajan, Aditya team

First Results from the Infrared Imaging Video Bolometer in SST-1 Tokamak  
Santosh P. Pandya, Kanchan Mahavar, Zubin Shaikh, Shamsuddin Shaikh, Hitesh Patel, Shwetang N. Pandya, Kumar Ajay, J. Govindarajan, SST-1 Team

Numerical Calculation of Runaway Electron Energy Distribution Function and Estimation of Associated Synchrotron Emission Spectra for the SST-1 Tokamak  
Santosh P. Pandya, Shwetang N. Pandya, Kumar Ajay, J. Govindarajan

Development of Online Plasma Edge Density and Temperature Measurement Module Using MATLAB  
Ramesh Joshi, Gayatri Ashok and S.V. Kulkarni

X-Ray Crystal Spectroscopy: Survey and Edge Spectrometers for ITER  
Sanjeev Varshney

Progress in the Design of the ITER IN-DA ECE Diagnostic  
Ravinder Kumar, Suman Danani, H.K.B. Pandya, Sajal Thomas, V.Kumar, G.Taylor, V.S.Udintsev, G.Vayakis, M. Walsh

An Overview of Resonance Probe for Diagnosing Complex Plasmas  
S. K. Karkari

Analysis of 2-Dimensional Total Radiation Power Loss Profiles Measured With Tangential Viewing Infrared Imaging Video Bolometer on the ADITYA Tokamak  
Shwetang N. Pandya, Santosh P. Pandya, Kanchan Mahavar, Zubin Shaikh, Shamsuddin Shaikh, Kumar Ajay, ADITYA Team

Investigation to Increase Thermal Sensitivity of Infrared Imaging Video Bolometer Using Finite Element Analysis and Comparison with Experimental Results for Different Ultra Thin Metal Foils Used As Radiation Absorbing Element  
Hitesh Patel, Santosh P. Pandya, Kanchan Mahavar, Shwetang

N. Pandya, Kumar Ajay

Monte Carlo Simulation of Fixed-Anode X-Ray Source Spectra  
Sapna Mishra, Sanjeev Varshney, T.Sai Chaitanya, Vinay Kumar

Conceptual Design of Space Resolved Crystal Spectrometer for Aditya Upgrade Tokamak  
M. B. Chowdhuri, N. B. Pablant, J.Ghosh

Optical Imaging of SST-1 Plasma  
Manoj Kumar, Vishnu Chaudhary, Ajai Kumar, SST-1 team

Development and Testing of Prototype Soft X-Ray Imaging Camera in ADITYA Tokamak  
Jayesh V. Raval, Praveena Kumari, Vismaysinh Raulji, Minsha Shah, S. Purohit, Y.S. Joisa, Rachana Rajpal, Aditya team.

Design of Charge Exchange Diagnostic System for SST-1 Tokamak  
Snehlata Gupta, Santosh P. Pandya, Hitesh Patel, Kumar Ajay

Developing High Temperature Compatible Langmuir Probes and Data Acquisition System for CIMPLE-PSI  
Puspalata Sah, N.Aomoa

Modbus Based Integration of Stepper Motor Drives for Probes Positioning in Large Volume Plasma Device  
R. Sugandhi, P. K. Srivastava, A.K. Sanyasi, Prabhakar Srivastava, L.M. Awasthi

A Novel Design of Emissive Probe for Plasma Potential Measurements in LVPD  
P. K. Srivastava, A. K. Sanyasi, L. M. Awasthi

In-SituPlane Switching (IPS) Heating Mechanism for High Density Plasma Source in LVPD  
P. K. Srivastava, Prabhakar Srivastava, A. K. Sanyasi, R. Sugandhi, L. M. Awasthi and S. K. Mattoo

Plasma Flows Measurement by Using Gundestrup Probe in ADITYA Tokamak  
Deepak Sangwan, R Jha, R. Tanna, R. Manchanda

Observation on C III and H $\alpha$  Emissions from the Vicinity of Aditya Tokamak Limiter Using A Limiter Viewing Diagnostics  
Roshin Raj S, R. Manchanda, M. B. Chowdhuri, Nilam Ramaiya, Niral Virani, J. Ghosh, Aditya team

Measurements of Chord Averaged Plasma Density in SST-1 Tokamak

P. K. Atrey, Umeshkumar C. Nagora, B. K. Shukla, Dhaval Pujara, S. Mukherjee

Development of a Segmented Plasma Torch Assisted Simple Experimental System to Be Used for High Heat Flux Testing and Plasma Surface Interaction Studies

Ngangom Aomoa, Mayur Kakati

Measurement of Bulk Plasma Temperature Using N<sub>2</sub>Molecular Spectra in 6 MW Plasma Wind Tunnels At VSSC, Trivandrum

Niral Virani, J. Ghosh, Nilam Ramaiya, R. Manchanda, M. B. Chowdhuri, Aravindakshan Pillai.L, Sreenivas.N, Krishnaraj.K

Detection of NA D Spectral Lines and Their Usage in Monitoring the Reduction Processes of Iron Oxide In Microwave Hydrogen Plasma

Sarita Das, Debi Prasad Das, Priyanka Rajput, Joydeep Ghosh, Bhagyadhar Bhoi, Barada Kanta Mishra

Development of Tungsten Coated Graphite Tiles for Fusion Plasma Applications

Uttam Sharma, Sachin Singh Chauhan, A. K. Sanyasi, Jayshree Sharma, K K Choudhary J.Ghosh

Studies on Structural and Morphological Properties of Tungsten Nanoparticles Synthesized by a Plasma Expansion Technique

Trinayan Sarmah, Puspallata Sah, N. Aomoa, M. Kakati

Effect of Cold Plasma Treatment on Seed Germination

R.Rane, A.Vaid, A.Vikram, A.Thakur, S.Mukherjee

Development of Atmospheric Pressure Plasma Torch Array for Blood Coagulation

Akshay Vaid, Chirayu Patil, Adam Sanghariyat, Ramkrishna Rane, Subroto Mukherjee

Effect of Plasma Parameters on the Growth of Aluminum Nitride Thin Film

Partha Saikia, Bipul Kumar Saikia, Subroto Mukherjee, Rama Krishna Rane, Joseph Alfonsa

Impedance Matching Between Pulse Forming Network (PFN) and Washer Plasma Gun for Optimization of Input Energy Delivery to the CPS Device

S. Samantaray, R. Paikaray, G. Sahoo, P. S. Das, J. Ghosh, A. Sanyasi

Pulsed Electrical Exploding Wire for Production of Nano Powders

S. Borthakur, N. Talukdar, N.K. Neog, T.K. Borthakur

Electron Beam Welding: Heat Flow Model Including Peclet Number

Suresh Akella, Harinadh Vemanaboina, Ramesh K Buddu

Pulsed Power Plasmas for Production of Nanoparticles

Anurag Shyam, Rashmita Das, Rishi Verma

Design and Analysis of Duct Liner for Vacuum Vessel of Indian Test Facility

Dhananjay Kumar Singh, J. Joshi, A. Yadav, G. Roopesh, H. Patel, Rambilas Prasad, MV Nagaraju, S. Pillai, D. Sudhir, M. Patel, C. Rotti, M. Bandyopadhyay, A. Chakarborty

Calculation of Error Matrix using Finesse for the supervisory control of an optical cavity

S. Sunil, Amit K. Srivastava, Ziauddin Khan

Validation of Sandwich bottom plate to rib weld joint for ITER Cryostat

Mitul Patel, Vaibhav Joshi, Rajnikant Prajapati, Girish Gupta, Jagrut Bhavsar, Mukesh Jindal, Amit Palaliya, Gaurav Jogi, Vipul More, Avik Bhattacharya, Saroj Jha, Manish Pandey, AnilKumar Bhardwaj, Hemal Desai, Pandurang Jadhav, Niyant Mehta

Excitation Energy Dependence of Dye Fluorescence Lifetime in the Presence of Metal Nanoparticles

Sarayoo Sasidharan, Tintu Kuriakose, Jinto Thomas, Ravi A.V. Kumar, Reji Philip

Modbus TCP/IP Communication for Slow Controller of Local Control Unit for ITER-INDIA Gyrotron Test Facility (IIGTF)

Deepak Mandge, Vipal Rathod, Ronak Shah, Anjali Sharma, Sharan Dilip, Amit Yadav, Rajvi Parmar, S. L. Rao

Pseudopotential Approach to Ion Acoustic Waves in a Relativistically Degenerate Quantum Plasma

Anay Basak, Saheli Das, Suchandra Mandal, Shoubhik Pramanik, Ravneet Kaur Gill, Sibarjun Das, Basudev Ghosh, S.N.Paul, Himangshu Sahoo, Sreyasi Banerjee, Krishanu Chatterjee, Rakesh Moulick, Swarniv Chandra





Simulation of Plasma Layer during Hypersonic Re-entry Vehicles

Eashan Saikia, Siddharth Bhattaroy, S.S. Kausik

*DAE Symposium on Nuclear Physics, Banaras Hindu University, Varanasi, 8-12 December 2014*

Design of Safety Interlock System for Accelerator Based 14-MeV Neutron Generator

Bhumi Chaudhari, Sudhirsinh Vala, M. Abhangi, C V S Rao, T K Basu and B Sarkar

Preliminary Design of Low Energy Beam Transport (LEBT) system for Accelerator based 14 MeV Neutron Generator

Asha Panghal, Sudhirsinh Vala, M. Abhangi, C V S Rao, T K Basu and B Sarkar

Anomalous behavior of  $(n,\alpha)$ ,  $(n,p)$  cross-section for  $^{55}\text{Fe}$  and  $^{59}\text{Ni}$  with low energy neutrons

Bhawna Pandey, P.M. Prajapati, Sudhirsinh Vala, M. Abhangi, Namita Yadav, T.K. Basu, CVS Rao, B. Sarkar

Preliminary design of Low Energy Beam Transport System for accelerator based 14 MeV Neutron Generator

Asha Panghal, Sudhirsinh Vala, Mitul Abhangi, C.V.S Rao, T.K Basu and B. Sarkar

Helium-Hydrogen generation arising from the  $^{55}\text{Fe}(n,x)$  reaction and its impact on fusion reactor

Bhawna Pandey, Chandan Danani, P.M. Prajapati, R. Makawana, S. Jakhar, A.T.T. Mostako, Sudhirsinh Vala, T.K. Basu, CVS Rao, B. Sarkar

*5th International Congress on Computational Mechanics and Simulation (ICCMS 2014), Chennai, 10-13 December 2014*

Assessment of Structural Integrity of ITER-VVPSS Tank

Gaurav Jogi, Girish Gupta, Avik Bhattacharya, Vipul More, Anil Kumar Bhardwaj

Design and Non-Linear Analysis of VS Coil Feeder Oblong bellows of Cryostat

Saroj Kumar Jha, Girish Gupta, Manish Kumar Pandey, Vipul More, Anil Kumar Bhardwaj

*DST Nanomission Review Meeting, Sastra University, Tanjore, Tamil Nadu, 29th December 2014 to 1st January 2015*

Nanopatterns for Plasmonic Study

M. Ranjan

*International Conference on Frontiers of Spectroscopy, Physics Department, Banaras Hindu University, Varanasi, 10-12 January 2015*

Compact Optical Setup for X-Ray Crystal Spectrometer for High Temperature Plasmas

Namita Yadav, Sanjeev Varshney, Sapna Mishra, Nirav Bhaliya and Vinay Kumar

Simulation of Cu-target X-ray source using Monte Carlo method

Sapna Mishra, Sanjeev Varshney, Sai T Chaitanya, Namita Yadav and Vinay Kumar

Winter School on Physics with Trapped Charged Particles, Les Houches, France, 19-30 January 2015

Estimation of RF heating and cooling rates of an electron-positron plasma confined in a Combined Trap

Manu Bajpai

Electron Plasmas in Small Aspect Ratio Toroidal Experiments

Lavkesh T. Lachhvani, Sudip Sengupta, Manu Bajpai, Yogesh Yole, P. K. Chattopadhyay, Sambaran Pahari

*User's workshop for utilization of Indus beamlines, RRCAT, Indore, 22-23 January 2015*

Proposal for Reflectivity measurement of x-ray optical measurements using Indus-1/BL-04

Sanjeev Varshney

*2nd National Conference on Emerging Trends in Engineering, Technology & Management, (NCEETM-2015), Indus University, Ahmedabad, 30-31 January 2015*

Characterization of Titanium Nitride (TiN) Thin Films Deposited by DC Reactive Magnetron Sputtering

A. Christie, B. Ganguli, B. Rehani

*29th ISMAS International Symposium on Mass Spectrometry (ISMAS-2015), Jodhpur, Rajasthan, 2-6 February 2015*

Study of Impurities in Aditya Tokamak during Different Con-

ditions Using Quadrupole Mass Analyzer

S. B. Bhatt, K. A. Jadeja, K. M. Patel, N.D. Patel, M. K. Raval, J. Ghosh and Aditya Team

**4th International Conference on Current Developments in Atomic, Molecular, Optical & Nano Physics with Applications (CDAMOP-2015), University of Delhi, 11-14 March 2015**

Neutral drift velocity measurements in biased DC plasma sheath using Doppler shift spectroscopy

K. Vara Prasad, Joydeep Ghosh, Nilam Ramaiya, Niral Virani, M.B. Chowdhuri, R. Manchanda and S. Benerjee

**4th International Conference on Materials Processing and Characterization, Gokaraju Rangaraju Institute of Engineering and Technology, Hyderabad, 14-15 March 2015**

Hydrogen in Stainless Steel as Killing Agent for UHV: A Review

Manoj Kumar Gupta, Abhinav Priyadarshi, and Ziauddin Khan

Studies of Thermal Behavior on Activated Carbons for the Selection of Regeneration Scheme

Samiran Mukherjee, Pratik Nayak, Jyoti Agarwal, and Ranjana Gangradey

**Joint ICTP-IAEA Advanced School and Workshop on Modern Methods in Plasma Spectroscopy, International Center for Theoretical Physics, ICTP Miramare-Trieste, Italy, 16-27 March 2015**

Doppler Shift Spectroscopy Diagnostic for Indian Test Facility (INTF)

Dass Sudhir, M. Bandyopadhyay, G. Bansal, K. Pandya. A. Yadav, J. Joshi, A. Chakraborty

Investigation of the Role of Neutrals in Edge Transport Barriers using PMT Array Based Spectroscopic System in Aditya Tokamak

Nilam Ramaiya, R. Dey, R. Manchanda, M.B. Chowdhuri, S. Banerjee, N. Virani and J. Ghosh

Current needs and development in X-ray Crystal Spectroscopy for ITER

Sanjeev Varshney, Sapna Mishra, Siddharth Kumar, Vinay Kumar, Robin Barnsley, Gunter Bertschinger, Martin O Mullane, Philippe Bernascolle

Design and Simulation of Cu target X-ray Source for ITER X-ray Crystal spectrometers

Sapna Mishra, Sanjeev Varshney, T Sai Chaitanya, Gunter Bertschinger, Robin Barnsley, Vinay Kumar

**Afro-Asian International Conference on Science, Engineering & Technology, (AA-IC-SET-2015), GEC Bharuch, Near Vadodara, Gujarat, India, 27-28 March 2015**

Multiphysics simulation of laser cladding process - A review

R P Parekh, R I Patel, B Ramesh Kumar

#### PATENT APPLIED

A System to Generate High Power Density Dielectric Barrier Discharge Plasma in Ambient Air Medium

V. Jain, A. Visani, A. Sanghariyat, S. K. Nema, S. Mukherjee  
Patent application no.:1704/MUM/2014

#### AWARDS and ACHIEVEMENTS

Collisionless Microtearing Modes in Large Aspect Ratio Tokamaks

Aditya K. Swamy, R. Ganesh, J. Chowdhury, S. Brunner, J. Vaclavik, and L. Villard won **Best Poster** Award at Joint IAEA - ICTP Advanced College on Plasma Physics - Trieste, Italy, 18-29 August 2014

Acoustic emission studies on weld defected nuclear grade materials

S.V. Ranganayakulu, N V S M Ravi Kiran, J Shiva Raju, B Ramesh Kumar won **Best Paper** Award at National Symposium on Acoustics(NSA)-2014 (ACOUSTICS-2014), All India Institute of Speech & Hearing, Manasagangothri, Mysore, 12-14 November 2014

Ultrasonic Inspection of High Heat Flux (HHF) tested Tungsten Monoblock Type Divertor Test Mock ups

Kedar Bhope, Mayur Mehta and S.S.Khirwadkar won Second Prize for **Best Oral and Paper Presentation** at National Seminar and Exhibition on Non-Destructive Evaluation (NDE-2014), Pune, India, 4-6 December 2014

Data Acquisition and Control System for the Setup of New High Heat Flux Test Facility at IPR

Sunil Belsare, S S Khirwadkar, Rajamannar Swamy, Yashashri Patil, Ritesh Sugandhi, Kedar Bhope, Kalpesh



Galodiya, Prakash Mokaria, and Tushar Patel won **Z. H. Sholapurwala Award** Second Prize for the poster presentation at 29th National Symposium on Plasma Science & Technology and the International Conference on Plasma & Nanotechnology (PLASMA 2014), Mahatma Gandhi University, Kottayam, Kerala, India, 8-11 December 2014

The Usefulness of Oblique View Electron Cyclotron Emission (ECE) Calculations for ITER

P.V.Subhash, Yashika Ghai, Amit K.Singh, Aparna M.P, Divya V.S, Basitha Thanseem T.K, Hitesh Pandya, P. Vasu won **Best Poster** Award at 29th National Symposium on Plasma Science & Technology and the International Conference on Plasma & Nanotechnology (PLASMA 2014), Mahatma Gandhi University, Kottayam, Kerala, India, 8-11 December 2014

Institute for Plasma Research (IPR) won the **Rajbhasha Shield** (2013-2014) for carrying out work in Hindi. Rajbhasha shield was presented to IPR at 16th Akhil Bhartiya Rajbhasha Sammelan held at IPR during 29-30 January 2015

Hindi newsletter "PlasmaJyoti" won trophy for being the **Best Hindi magazine** among the DAE funded institutes for 2013-2014 for the third successive year. Trophy was presented to IPR at 16th Akhil Bhartiya Rajbhasha Sammelan held at IPR during 29-30 January 2015

Pratibha Gupta and Suryakant Gupta were awarded the **DAE Hindi Sevi Samman** 2013-2014 for creative contributions in Hindi at 16th Akhil Bhartiya Rajbhasha Sammelan held at IPR during 29-30 January 2015

Utkarsh Healthcare Foundation India celebrated womanhood and women's achievement by felicitating 11 women achievers of Gujarat. The program entitled "**Women Excellence Awards 2015**" was held at Hotel Regenta, Ahmedabad on 8th March 2015. Prof. Amita Das of Institute for Plasma Research, was one of the recipients of the Achievers Award for her contribution as a scientist and innovator.

Institute for Plasma Research has been recognized as **Scientific and Industrial Research Organization (SIRO)**, by Department of Scientific and Industrial Research (DSIR), Government of India vide letter no. 11/624/2013-TU V dated 09-May-2014. This shall facilitate the interaction of IPR with industries and lead to improved technology commercialization.

## E.4 Invited Talk Delivered by Staff

### DHIRAJ BORA

Gave an invited talk on "Vacuum Technology in Mega Science Projects", Balakrishnan Memorial Lecture of Indian Vacuum Society, BARC, Mumbai, 17th April 2014

Gave a Key Note address "Role of Plasma Science in Fusion Experiments", 3rd PSSI-Plasma Scholars Colloquium and National Workshop on Exploring Plasma Technology for Material Processing, VIT Chennai, 3-5 July 2014

Gave an invited talk on "Burning Plasma Experiments in ITER", TIFR NSF Colloquium, Mumbai, 13 August 2014

Gave an invited talk on "ITER and Beyond", Variable Energy Cyclotron Centre Colloquium, Kolkata, 20th August 2014

Gave an invited talk on "Indian Fusion Programme", SOFT 2014, San Sebastian, Spain, September 2014

Gave an invited talk on "Fusion - An alternate source of energy", 102nd Indian National Science Congress, Mumbai University, Kalina, 05th January 2015

Gave an invited talk on "Fusion - An alternate source of energy", Public Lecture organized by Indian Institute of Technology and Centre for Science and Society, New Delhi at IITD, 04th February 2015

Gave an invited talk on "Need and Fusion Energy: Indian Scenario", XXIX Gujarat Science Congress, Gujarat Science City, Ahmedabad, 28 February 2015

### NIRAV JAMNAPARA

Gave an invited talk on "Surface Engineering: Plasma Processing Perspective", at Department of Metallurgy, Government Engineering College, Gandhinagar, 4 April 2014

Gave an invited talk on "Thermal Plasma processing", at Plasma Scholars' Conference, (PSC-PSSI 2014), at VIT Chennai Campus, Chennai, 4-5 July 2014

### SURYAKANT B. GUPTA

Gave an expert lecture on "Emerging Trends of Plasma Technology in Mechanical Engineering" at Mechanical Engineer-

ing Department, Nirma University, Ahmedabad, 10 April 2014

Gave an invited talk on “An update of spacecraft charging research in India: Spacecraft Plasma Interaction eXperiments SPIX -II” at 13th Spacecraft Charging Technologies Conference (SCTC-2014), at JPL CALTECH, LA, USA, 23-27 June 2014

Gave an invited talk on “Plasma Technology: An Engineering perspective for Societal Benefits” at Sankalchand Patel College of Engineering (SPCE), Visnagar, Gujarat, India on 13 September 2014

Gave an invited talk on “Societal benefits of plasma technology for the betterment of mankind” at an event on the theme of societal applications of Atomic Energy, organized by Heavy Water Board, Department of Atomic Energy, AERB Auditorium, Anushakti Nagar, 21 November 2014

Gave an invited talk on “Environmental protection and immense contribution of plasma technology in social sectors”, at 16th All India Department of Atomic Energy Hindi Sammelan, Institute for Plasma Research, Gandhinagar, 29-30 January 2015

Gave an invited talk on “Multidimensional applications of eco-friendly plasma technology” at National seminar on Occupational and Environmental Health-Present Scenario [Hindi], at NIOH, Ahmedabad, 20-21 February 2015

Gave an invited talk on “Science for Nation Building” on the occasion of Celebration of National Science Day organized by Institution of electronics and communication engineers [IETE] at IETE, Ahmedabad Chapter on 28 February 2015

Gave an invited talk on “Plasma technology and its various uses for social welfare”, at Scientific Seminar [Hindi] at NPCIL, Tarapur, on 17 March 2015

#### **KEDAR BHOPE**

Gave an Invited talk on “Non-Destructive Testing” at K J Institute of Technology, Savli, Baroda, 17 April 2014

#### **SUDIP SENGUPTA**

Gave an Invited talk on “Sheet Simulation” at SERB School on High Intensity Laser Plasma Interaction: Theory and Simulation, IIT Delhi, 5-23 May 2014

Gave an Invited talk on “Breaking of relativistically intense wake-waves excited by an ultra-relativistic electron beam in a cold plasma” at 2nd National Symposium on Nonlinear & Complex Phenomena (NSNCP-2015), Institute of Advanced Study in Science & Technology (IASST), Guwahati, 26-28 March 2015

#### **S. SUNIL**

Gave an Invited talk on “Investigation of interaction between 3-modes in an 80 meter Fabry-Perot cavity for the study of Parametric Instability in a Gravitational wave detector” at IISER, Thiruvananthapuram, Kerala, 26 May 2014

#### **V.L. TANNA, S. PRADHAN and CRYO TEAM (SST-1)**

Gave an Invited talk on “SST-1 Cryogenics Overview with New Developments & Up-gradation plans in SST-1” at Theme Meeting on Researchers & Industry Interaction in Cryogenics, Hotel Surya Palace, Alkapuri, Baroda, 23 August 2014

Gave an Invited talk on “Recent experience and Observations on SST-1 Helium Cryogenic System” at 6th International Workshop on Cryogenics Operations (CRYO-OPS-2014), Science and Technology Facility Council, Daresbury Laboratory, United Kingdom, 10-12 November 2014

#### **R. GANESH**

Gave an Invited talk on “Computer Simulations as a useful tool to understand exotic plasmas” Invited 3-Lecture Series at IAEA-ICTP Advanced College on plasma physics, CTP, Trieste Italy, 18-29 August 2014

Gave an Invited talk on “Global collisionless microtearing modes in large aspect ratio Tokamaks” at Theory of Fusion Plasmas, Joint Varenna-Lausanne International Workshop, Villa Monastero, Varenna, Italy, 1-5 September 2014

Gave an Invited talk on “Physics of Microtearing modes in collisionless Tokamaks” at LPP, Ecole Polytechnique Paris, Paris, France, 6-14 September 2014

Gave an Invited talk on “Large Scale Particle-In-Cell Simulations of Steady State Microturbulence in Tokamaks” at International Congress on Plasmas Physics (ICPP), Lisbon, Portugal, 15-19 September 2014



**MUKESH RANJAN**

Gave an invited talk on “Investigation of sticking behaviour of silver atoms on patterned substrate with RBS” at National Seminar on Crystallography & National Workshop on CADD, at Sardar Patel University, Vallabh Vidyanagar, Gujarat, 1-3 September 2014

Gave an invited talk on “CZTS based solar cell and plasmonics incorporation” at Loughborough University, UK, in October 2014

Gave an invited talk on “Investigation of yield behaviour and surface patterns after the bombardment of low energy ion on surfaces”, at Linear Tokamak Divertor Simulators for PSI Studies, Sonapur, Assam, 24-26 November 2014

Gave an Invited talk on “Nano Prodyogiki avum samaj kalyan hetu uske vibhin upayaog” (in Hindi) at One Day Hindi Seminar, NPCIL, Tarapur on 17 March 2015

Gave an Invited talk on “Large Quantity nanoparticle production and surface nano-patterning” at one day seminar on Industrial applications of Plasma based Technologies, AMA, Ahmedabad, 27 March 2015.

**C. BALASUBRAMANIAN**

Gave a guest lecture on “Thermal Plasma processing of nanomaterials” at Ca’ Foscari University of Venice, Italy, in September 2014

Gave an invited talk on “Thermal Plasma Processing of Nanomaterials – Possibilities and Challenges” at Advanced Materials for Energy and Environmental Applications, AMEEA-2015, at Bharathiar University, Coimbatore, 18 -20 March 2015

**SARVESHWAR SHARMA**

Gave an Invited talk on “Study of collisionless heating and transient electric field phenomena in capacitively coupled plasma discharges” at Princeton Plasma Physics Laboratory (PPPL), Princeton, NJ, USA, 22 October 2014

**P.M.RAOLE, S. DESHPANDE, S. KHIRWADKAR, C. DUBE, P.MAYA, C. JARIWALA, P. RAYJADA, SAI KRISHNA**

Gave an Invited talk on “Ion irradiation of Fusion Reactor Materials to simulate Radiation damage by neutron irradiation and H/D/He retention” at CPP-IPR Workshop on Linear Tokamak Divertor Simulators for PSI Studies, CPP, Guwahati, India, 24-26 November 2014

Gave an Invited talk on “Indian perspective on requirements and development of Fusion Reactor Materials” at National Conference on Materials for Energy Conversion and Storage (NCMECS-2015), VIT University, Chennai, 12-14 March 2015

**SHANTANU KARKARI**

Gave an Invited talk on “An Overview of Ongoing Experiments on Applied Plasma Physics Experiments in Linear Device” at Princeton Plasma Physics Laboratory, 29th October 2014

Gave an Invited talk on “Overview of current developments on Applied Plasma Physics Experiments in Linear Device” at Workshop on Linear Tokamak Divertor Simulator, CPP-IPR, Guwahati, 24-26 November 2014

**BHAWNA PANDEY**

Gave an Invited talk on “EMPIRE - A Modular System for Nuclear Reaction Modelling and Nuclear Data Evaluation” at Indo-Czech cooperation Workshop on Monte Carlo Simulation Technique and Applications, Department of Physics, Maharaja Sayajirao University of Baroda, 1-6 December 2014

**A. K. SAHU, N C GUPTA, H DAVE, V. PATEL, H. VYAS, D. BOHRA, N. MAMGAIN, H. SHAH, P. THUMMAR, S. PARAMKUSAM**

Gave an Invited talk on “Indigenous Development of kW Class Helium Refrigerator-Cum-Liquefier: Present Status and Future Plan” at 25th National Symposium on Cryogenics, University of Hyderabad, Hyderabad, Telangana, 8-10 December 2014

**ANIL KUMAR TYAGI**

Gave an Invited talk on “Fusion as Upcoming Resource of clean Energy” at popular lecture series for B.Sc. Students of Pramukh Swami Science & H. D. Patel Arts College (PSSH-DA), Kadi, 16 January 2015

**AMITA DAS**

Gave a Keynote talk on “Plasma: an interesting complex medium” at the Indian Women Science Congress, Mumbai University, 3-7 January 2015

Organized ASHULA (ASian core program for High energy density science Using intense LASer photons) conference at Lonawala, Khandala from 20-21 January 2015

Gave an Invited talk on “Turbulence in Self-Generated Magnetic Fields” at 2nd National Symposium on Nonlinear & Complex Phenomena (NSNCP-2015), Institute of Advanced Study in Science & Technology (IASST), Guwahati, 26th March 2015

**MRITYUNJAY KUNDU**

Gave an Invited talk on “Anomalous collisional absorption of laser light in under-dense plasma” at Asian core program for High energy density science using intense Laser photons, The Dukes Retreat, Khandala, Lonavala, Maharashtra, 20-21 January 2015

**SARVESHWAR SHARMA, S. K. MISHRA, P. K. KAW**

Gave an Invited talk on “Transient Electric Field Phenomena in Single Frequency Capacitive discharges” at Aerothermal & Plasma Physics Laboratory (APPL), National Chiao Tung University (NCTU), Hsinchu, Taiwan, 12 February 2015

**N. RAMASUBRAMANIAN**

Gave an Invited talk on “Powering cities with multiple mini-suns - A Challenge for the 21st Century” at UGC sponsored National Conference on Recent Trends and Advances in Physics, MDT Hindu College, Tirunelveli, 19-20 February 2015

Gave a special evening lecture on “Powering cities with multiple mini-suns - A Challenge for the 21st Century” on 5th March 2015 as a part of DST-SERB School on “Ion Interaction with Matter” held at Department of Physics, Saurashtra University, Rajkot during 2-21 March 2015.

**S.K. NEMA**

Gave an Invited talk on “Plasma Technologies for Surface Modification of Textiles” at National Conference on Ad-

vances in Plasma Science & Technology (APST-2015), Sri Shakthi Institute of Engg. & Technology, Coimbatore, 20 February 2015.

**GAUTAM C SETHIA**

Gave an Invited talk on “A Chimeric view of the metastability of brain dynamics” at Hands-On School on Nonlinear Dynamics, Institute for Plasma Research, 20 February 2015.

**S. SHRAVAN KUMAR**

Gave an Invited talk on “Citation Indexing: Scope and Development”, at Centre for Library and Information Science, Central University of Gujarat, Gandhinagar, 21 February 2015.

**BHARGAV PANDYA**

Gave an Invited talk on “Research Opportunities and Trends in Applied Energy” at M. Tech Student Research Awareness Programme, Pandit Deen-Dayal Petroleum University, Gandhinagar, Gujarat on 7th March 2015.

**SANJEEV VARSHNEY**

Gave an Invited talk on “Fusion Plasma Diagnostics by means of Atomic emissions in X-ray range” at 4th International conference on Current developments in Atomic, Molecular, Optical and Nano Physics with Applications, Delhi University, Delhi, 11-14 March 2015.

Gave an Invited talk on “Current needs and developments of ITER XRCS systems” at Joint ICTP-IAEA Advanced School and Workshop on Modern Methods in Plasma Spectroscopy, International Center for Theoretical Physics, ICTP Miramare-Trieste, Italy, 16-27 March 2015.

**AMULYA SANYASI**

Gave an Invited talk on “Plasma Science & Technology and path to Fusion Energy” at ASME SPDC - 2015 an International Conference at B. H. Gardi College of Engineering and Technology (B.H.G.C.E.T.), Rajkot, Gujarat on 15th March 2015.

**R. RANE**

Gave an invited talk on “Plasma based PVD Coatings”, at one day seminar on Industrial applications of Plasma based



Technologies, AMA, Ahmedabad, organized by FCIPT/IPR, 27 March 2015.

### **M. KAKATI AND N. AOMOA**

Gave an Invited talk on “Development of a Linear Tokamak Divertor Simulator for Plasma Surface Interaction Studies and Some Preliminary Results from Tungsten-Plasma Exposure Experiments” at CPP-IPR Workshop on Linear Tokamak Divertor Simulators for Plasma Surface Interaction Studies, CPP, Sonapur, Assam, India, 24-26 November 2014

### **M. KAKATI**

Gave an Invited talk on “Recent trends in Applied Plasma Physics Research; Some results from CPP-IPR”, at National Science Day Celebration, Dept. of Physics, Assam University, Diphu Campus, 28 February 2015

*Invited talks given at 29th National Symposium on Plasma Science & Technology and the International Conference on Plasma & Nanotechnology, Mahatma Gandhi University, Kottayam, Kerala, India, 8-11 December 2014*

P. I. JOHN gave a Keynote talk on “From Electrojet to ITER: India’s Journey in Experimental Plasma Physics”.

AVINASH, M.SENGUPTA R.GANESH gave an Invited talk on “Plasma heating via adiabatic magnetic Compression-Expansion cycle”

MUKESH RANJAN gave an Invited talk on “Plasma for Plasmonics”

ABHIJIT MAJUMDAR, CHIRAYU PATIL, ADAM SANGHARIYAT, AKSHAY VAID, SUBROTO MUKHERJEE gave an Invited talk on “Non-Thermal Atmospheric Pressure Plasma for Bio-Medical Applications”

P. BANDYOPADHYAY, D.SHARMA, U.KONOPKA, A.SEN, P.K.KAW G.MORFILL gave an Invited talk on “Experimental Investigation of Spatio-Temporal Patterns and Shear Driven Instability in a Magnetized RF Plasma”

B. J. SAIKIA gave an Invited talk on “Radiation Transport Modeling: Stochastic vs. Deterministic Approach”

AJAI KUMAR gave an Invited talk on “Spectroscopy of Laser Induced Plasma”

V.L. TANNA gave an Invited talk on “Economics of Large Scale Cryogenic System for Fusion Devices”

CHANDAN DANANI gave an Invited talk on “Fusion Neutronics: An Overview”

BEDAKIHALE VIJAY, MACKLIN BRIAN, PETIT PATRICK, SHAW ROBERT, WILSON DAVID, BLACKLER KEN gave an Invited talk on “ITER Assembly - Approach, Planning and Current Status”

P.K.SHARMA gave an Invited talk on “Recent Advances in SST-1 LHCD System”

SURYA K PATHAK gave an Invited talk on “Microwave Sensors in Fusion Plasma”

JINTO THOMAS, KIRAN PATEL, VISHNU CHOUDHARY, VISHAL PILLAI, NEHA SINGH, AJAI KUMAR gave an Invited talk on “Laser Based Diagnostics for High Temperature Tokamak Plasma: Thomson Scattering Diagnostics in ADITYA and SST1”

L.M.AWASTHI gave an Invited talk on “Investigations on Plasma Turbulence: An opportunity to exploit in LVPD”

G. RAVI gave an Invited talk on “Enthalpy Probe Diagnostics for Thermal Plasma Measurements”

P.I.JOHN gave an Invited talk on “The Pervasive Plasma Socio-Economic Impact of Plasma Technologies”

## **E.5 Talks Delivered By Distinguished Visitors**

Ms. Kamy Chandrasekhar, Nuclear Engineering Department, University of Wisconsin, US, gave a talk on “Effective Variance Reduction and other MCNP Techniques for Deep Penetration Shielding Problems in Nuclear Fusion”.

Dr. Shailesh Desai, Director, Cardio Uno Plus Heart Disease Prevention Centre, Ahmedabad, gave a talk on “Health Education Awareness”

Dr. Namita Yadav, Banaras Hindu University, Varanasi, gave a talk on “Studies of bremsstrahlung spectra under impact of keV electrons on thick and thin targets”

Dr. Animesh Kuley, Department of Physics and Astronomy, University of California, Irvine, USA, gave a talk on “Particle

## Simulation of Radio Frequency Waves in Fusion Plasmas”

Dr. Sharad Kumar Yadav, University of Iowa, USA, gave a talk on “Rotational dynamics of cation in Ionic liquids and Ionic liquids mixture”

Prof. Hideaki Takabe, Institute of Laser Engineering, Osaka University, Osaka, gave a talk on “International joint experiments and theoretical studies on laboratory astrophysics in ILE, Osaka University”

Dr. Deepak K Gupta, Tri Alpha Energy, California, USA, gave a talk on “Progress on C2 Field Reversal Configuration (FRC) Plasma Device”

Dr. Debabrata Banerjee, Saha Institute of Nuclear Physics, Kolkata gave a talk on “Effect of non-Newtonian behaviour on low frequency wave and instability in dusty plasma”

Prof. Chin-Kun Hu, Institute of Physics of Academia Sinica, Taipei, Taiwan, gave a talk on “Universality and scaling in physical, biological, and social systems”

Prof. Mohammed Shahabuddin, Department of Physics and Astronomy, College of Science, King Saud University, Riyadh, Saudi Arabia, gave a talk on “MgB2 superconducting wire: Prospect for low field application especially in MRI”

Dr. Ram Prakash and PDT Team, (Plasma Devices Technology Lab), Microwave Tubes Division, CSIR-Central Electronics and Engineering Research Institute, Pilani, gave a talk on “Plasma Devices Research at CSIR-CEERI: Avenues for Collaboration”

Prof. Gorur Govinda Raju, Emeritus Professor, Head of Department (Retd.), University of Windsor, Ontario, Canada, gave a talk on “Role of Dielectric Theory in Engineering Insulation Problems”

Dr. Daly Davis, Tata Institute of Fundamental Research, Homi Bhabha Road, Colaba, Mumbai, gave a talk on “Dissociation Electron Attachment in Condensed Phase”

Dr. Christian Hopf, Max Planck Institute for Plasma Physics, Garching bei Munich, Germany, gave a talk on “Neutral Beam Current Drive Experiments on ASDEX Upgrade– A Status Report”

Dr. Noor Danish Ahrar Mundari, HOD, Electrical Electronics

Engineering, Arni University, Himachal Pradesh, gave a talk on “Development of Atomic Oxygen (AO) facility and its effects on Spacecraft Surface Charging”

Dr. Arun K. Bhattacharya, IEEE APS Distinguished Lecturer, Northrop Grumman Corporation, USA, gave a talk on the topics “Efficient Shaped Beam Synthesis in Phased Arrays and Reflectors” and “Advanced Horn structures for Reflectors and Phased Arrays”

Prof. Erich Griesmayer, CIVIDEC Instrumentation GmbH, Vienna, Austria, gave a talk on “Use of Diamond Detector Technology”

Dr. Syaml Kumar Dana, CSIR-Indian Institute of Chemical Biology, Jadavpur, Kolkata, gave a talk on “Synthetic Genetic Oscillators, Quorum sensing and Multistability”

Shri S.G. Belokar, General Manager (Safety, Health & Environment), Heavy Water Board, Mumbai, gave a talk on “Safety Management in Research and Development (R&D) Organisation”

Dr. Prithwish Nandi, Dept. of Nuclear Engineering, North Carolina State University Raleigh, USA, gave a talk on “Waxing and waning of dynamical heterogeneity in the super-ionic state”

Dr. Rameswar Singh, Laboratoire de Physique des Plasmas, Ecole Polytechnique, 91128 Palaiseau Cedex, France, gave a talk on “Geodesic acoustic modes”

Dr. Stephane Ethier, Deputy Head, Computational Plasma Physics Group, Princeton Plasma Physics Laboratory, gave a talk on “Global Gyrokinetic Simulations of Intrinsic Torque Reversal and Kelvin-Helmoltz Instability with the GTS Particle-in-Cell Code”

Dr. Bert Ellingboe, Dublin city University, gave a talk on “A high efficiency, large area CCP plasma source: Scaling high-VHF rf power delivery to large areas”

Mr. Vijay Bedakihale, ITER Organization, France, gave a talk on “ITER Assembly Approach, Planning and Current Status”

Dr. Tanmoy Basu, Institute of Physics, Bhubaneswar, gave a talk on “Ion-beam induced nanostructuring of Si: Fundamentals and some applications”



Prof. Roger Smith, Loughborough University, UK, gave a talk on “Models of surface modification through ion or plasma interactions”

Dr. H. Tuong, CEA, Cadarache, France, gave a talk on “Progress of WEST”

Dr. Jayashree Ray, Cryomagnetism Laboratory, Department of Physics and Astronomy, National Institute of Technology, Rourkela, Odisha, gave a talk on “Investigation Study of Magneto-electric Coupling in Multi-ferroic Bismuth Alloys”

Dr. Ujjwal Sinha, Instituto Superior Tecnico, Portugal, gave a talk on “Polarization Spectra from PIC Simulations of Collisionless Shocks”

Dr. Subhanarayan Sahoo, Trident Academy of Technology, Bhubaneswar, Odisha, gave a talk on “Frequency and Time Domain Behaviour of Modified CaTiO<sub>3</sub> Nanoceramics for Thermistor Application”

Dr. Bidyut Das, CPP-IPR, Guwahati, gave a talk on “Plasma Transport across Transverse Magnetic Filter Field in a Double Plasma Device”

Dr. Partha Saikia, CPP-IPR, Sonapur, Assam, gave a talk on “Plasma diagnostics of DC planar magnetron glow discharge”

Dr. Sanjib Sarkar, Department of Physics, Jadavpur University, Kolkata, gave a talk on “Experimental investigation on cogenerated dusty plasma”

Prof. Howard Wilson, Director, York Plasma Institute, University of York, Heslington, York, UK, gave a talk on “Models for small ELM regimes in tokamaks”

Prof. Howard Wilson, Director, York Plasma Institute, University of York, Heslington, York, UK, gave a talk on “Drift kinetic theory for Neoclassical Tearing Modes”

Prof. Ulrike Feudel, Universität Oldenburg, gave a talk on “Extreme events in excitable systems”

Mr. Somesh Vinayak Tewari, Accelerator and Pulse Power Division, BARC, Trombay, gave a talk on “Study of surface flashover of insulator in gases at high pressure”

## E.6 Colloquia Presented at IPR

Dr. Kushal Shah, Assistant Professor, IIT Delhi, on “Plasma

Dynamics in Paul Traps” (Colloquium #232)

Prof. Laxminarayan Raja, Dept. of Aerospace Engineering and Engineering Mechanics, University of Texas, Austin, on “High-Fidelity Computational Modeling of Plasma-Electromagnetic Wave Interactions in Materials Processing Reactors” (Colloquium #233)

Prof. Bruce T. Tsurutani, Jet Propulsion Laboratory, California Institute of Technology, Pasadena, CA, on “Non-linear Wave/Structure-Particle Interactions” (Colloquium #234)

Dr. V. Subrahmanyam, Department of Physics, IIT – Kanpur, on “Quantum Entanglement in Electron/Spin systems” (Colloquium #235)

Prof. P. Punit, Physics Department, IIT Bombay, Powai, on “Coupling chemo-mechanical oscillators” (Colloquium #236)

Dr. P.R.Vasudeva Rao, Distinguished Scientist & Director, Indira Gandhi Centre for Atomic Research, Kalpakkam, on “R&D for Fast Reactor Programme” (Colloquium #237)

Dr. Gautam C Sethia, Nonlinear Physics Division, Institute for Plasma Research, Gandhinagar, on “Chimera freed from the constraints” (Colloquium #238)

Prof. Uriel Frisch, University of Nice, France, on “Time-analyticity of Lagrangian particle trajectories in ideal fluid flow governed by the Euler equations: historical and modern perspectives” (via video conferencing) (Colloquium # 239)

Prof. Parameswaran Ajith, International Centre for Theoretical Sciences, Tata Institute of Fundamental Research, Bangalore, on “Gravitational-Wave Astronomy: A New Window to the Universe” (Colloquium # 240)

Dr. G. Rajasekaran, Institute of Mathematical Sciences, C I T Campus, Chennai, on “Hundred years of Fundamental Physics and a Crisis” (Colloquium # 241)

Prof. A. Thyagaraja, Culham Centre for Fusion Energy and Bristol University, on “Plasma Transport and Turbulence: Some Basic Principles” (Colloquium # 242)

Dr. Jong-Shinn Wu, Aerothermal & Plasma Physics Laboratory, Advanced Rocket Research Laboratory, Department of

Mechanical Engineering, National Chiao Tung University, Taiwan, on “Current Low-Temperature Plasma Related Research Activities at Aerothermal & Plasma Physics Laboratory” (Colloquium # 243)

Prof. A. Thyagaraja, Culham Centre for Fusion Energy and Bristol University, on “The Art and Science of Computational Plasma Physics” (Colloquium # 244)

Dr. D. K. Srivastava, Distinguished Scientist & Director, Variable Energy Cyclotron Centre, Kolkata, on “Discovery of Quark Gluon Plasma” (Colloquium # 245)

Prof. Parthasarathi Majumdar, Ramakrishna Mission Vivekananda University, Belur, on “The Quantum and the Continuum: Einstein’s Dichotomous Legacies” (Colloquium # 246)

Prof. Kunioki Mima, Graduate School for the Creation of New Photonics Industries and Institute of Fusion Nuclear, Universidad Politecnica de Madrid, on “Laser Plasma Physics with GEKKO XII-LFEX at Osaka University” (Colloquium # 247)

Prof. B. K. Dutta, BARC/ HBNI, on “Mechanical Properties of Material at Extended Irradiation for Next Generation Nuclear Reactors” (Colloquium # 248)

## E.7 Scientific Meetings Hosted by IPR

### *Workshop on Prevention and Response to Nuclear/Radiological Emergency, at IPR, Gandhinagar, 2-4 April 2014*

Workshop on “Prevention and Response to nuclear/radiological Threats/Emergency” was organized at Institute for Plasma Research, Gandhinagar during April 2 - 4, 2014 along with the nodal center, Bhabha Atomic Research Center, Department of Atomic Energy, Govt. of India. This was a first of a kind workshop arranged at IPR having specific aim to develop awareness among the first responders in the Gujarat State in case of a nuclear or radiological threat. The participants were officers in the rank of DSP, SP, Additional DGP from the Gujarat state Police force, Anti-Terrorist Squad, Intelligence Bureau, National Disaster Response Force (NDRF), Fire Brigade, Medical (doctors from Civil Hospital, Ahmedabad), safety and security committee members of Space Application Center and Forensic team. Among the distinguished guests were, the Director General of Forensic Science Laboratory,

Gandhinagar and Additional DGP, Gujarat state. Dr. Pradeepkumar A. S, Head, Radiation Safety Systems Division from BARC inaugurated the workshop and delivered the keynote address. Total 67 (Sixty seven) participants attended the workshop and 13 (Thirteen) lectures were delivered during the 3 (Three) days by 9 (Nine) faculty members from BARC and IPR. There were 5 (five) specific practical sessions, where live demonstrations were made for on-hand experience of the participants. The workshop was well appraised by the participants. The aim of the workshop was considered as fulfilled as the participants performed beyond expectations during questions/answers interactive session on different scenarios. A visit to IPR facilities, namely, Aditya and SST-1 were also arranged along with specific visit to the Neutronics Laboratory at IPR. This thematic workshop concluded with concluding remarks by Director, IPR and Director General of Forensic Science Laboratory, Gandhinagar.

### *Technology Day at IPR by National Instruments, IPR, Gandhinagar, 23rd & 24th June 2014*

National Instruments equips engineers and scientists, across industries, with tools that accelerate productivity, innovation, and discovery to meet not only grand but also daily engineering challenges in an increasingly complex world. A graphical system design approach leverages productive software and reconfigurable hardware platforms, along with a vast community of IP and applications, to simplify system development and arrive at solutions faster.

### *One day introductory school on variable angle spectroscopic Ellipsometer, FCIPT Seminar Hall, 31-10-2014*

### *CPP-IPR Workshop on Linear Tokamak Divertor Simulators for PSI Studies, Centre of Plasma Physics-Institute for Plasma Research (CPP-IPR), Sonapur 782 402, Assam, India, 24-26 November 2014*

### *TBM Division organized a bilateral technical workshop with team from Russian Federation for TBM related R&D activities at IPR from 25th to 27th November, 2014*

### *Indo-Czech Cooperation Workshop on Monte Carlo Simulation and Applications for Plasma & Tokamak Physics, Institute for Plasma Research, Gandhinagar, 5 December 2014*

As part of the DAE Diamond Jubilee year programme, a one-



day workshop on Monte Carlo Simulations and their applications for plasma physics was conducted in IPR in collaboration with the Department of Physics, Faculty of Science, MS University Baroda was organized by IPR on the 5th December 2014. The workshop was part of a three week Indo-Czech cooperation programme in applications of M-C techniques for nuclear research. The workshop at IPR started with the inaugural address by Mr. P.K. Atrey, the administration head of IPR, followed by talks by IPR scientists on application of M-C techniques for various aspects of plasma & tokamak physics. The speakers were Dr. R.Ganesh, Dr. Devendra Sharma, Dr. P.N. Maya and Dr. P.V. Subhash. An introductory lecture to nuclear fusion and ITER-India was given by Dr. Indranil Bandyopadhyay. The team visited both Aditya tokamak and basic physics labs at IPR. The soft copies of the lectures were also circulated among the participants.

*16th All India DAE Hindi Sammelan, Institute for Plasma Research, Gandhinagar, 29-30 January 2015*

## **E.8 MoUs Signed**

Academic collaboration agreement between IPR & GTU: An MoU was signed between IPR & GTU on 23-July-2014 for academic collaboration. The agreement was signed by and between Prof. Dhiraj Bora, Director, IPR; and Prof. Akshai Aggarwal, Vice Chancellor, GTU at GTU, Chandkheda, Ahmedabad. This agreement will facilitate registration of IPR scientists as Ph.D. supervisors in relevant disciplines under GTU. This registration will be helpful to faculties of state government engineering college who are willing to pursue Ph.D. with IPR scientists as supervisors

--!!!--

# Annexure I

## Outreach Programme for Public Awareness

### Activity at Bhat Village

The first activity under the outreach programme of IPR for Bhat village kick-started on 13th October 2014. This 10 day course trained the local people in the basics of computer operation as well as data entry and usage of Microsoft Word in English and Gujarati languages. The first batch of 10 women from Bhat village completed their course on 30th October. The response to this programme has been immense with over 150 people (both men, women and children) from the village signing up for the programme which will be conducted in batches of 10. IPR computer center has installed five refurbished PC's at the Gram Panchayat building at Bhat village for this programme.



### National Science Day Celebrations

As part of the Diamond Jubilee celebrations of DAE, IPR organized National Science Day-2015 at its campus at Bhat, Gandhinagar from January 9-10, 2015. Various events like exhibition of Science Models from schools, demonstration of fundamental scientific principles and ideas by IPR staff, poster presentations, Science quiz, Essay competitions, Eloquence competitions for students etc. were organized to motivate the young minds towards science and technologies. More than 600 students from various schools from all over Gujarat participated in this programme. The campus was open for public visit from 10.00 am to 4.00pm for the two days and free transportation was provided from RTO circle, Ahmedabad to IPR. School students as well as common public were given guided tour of IPR to acquaint them with the research work being done and the cutting edge technologies being developed and used at the Institute in the field of Plasma and controlled thermo-nuclear fusion. They were also shown the first Indian tokamak Aditya and the superconducting Steady State Tokamak-1. The event was inaugurated by Prof. Dhiraj Bora, Director. Prizes and certificates were given to the winners during the concluding session. The social outreach programme envisaged in the jubilee year has several activities to create public awareness about the scientific and technological achievements of the nation as well as on emerging technologies and its prospects. Radiological Emergency Response Centre has also participated in the programme and demonstrated various radiation instruments and exposed the role of ERC in Radiological emergencies. A working model was also demonstrated to illustrate how nuclear reactors are safe.





*Photos from National Science Day Celebrations at IPR as a part of the Outreach Programme*



## Annexure II

### Representation of SCs, STs and OBCs

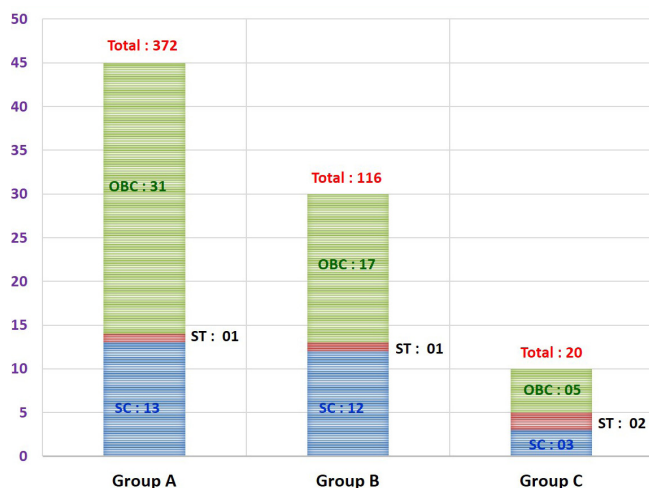

*Representation of SCs, STs and OBCs in the organization as on 31-March-2015*



*Shri Rajubhai Parmar, Hon'ble Member of the National Commission for Scheduled Castes, Govt. Of India visiting IPR*

Shri Rajubhai Parmar, Hon'ble Member of the National Commission for Scheduled Castes, Govt. Of India (A Constitutional Body under Article 338 of the Constitution of India) visited the Institute on December 24, 2014. He had a meeting with the Director, the members and the management. He expressed his satisfaction regarding the implementation of the policy by the Institute. He also appreciated the congenial working environment and the technologies developed by the Institute for green environment and advised to propagate it more especially to Municipal Bodies and Nagar Palikas such that the society gets the optimum benefit of the same.